



VIVA BOARD

CEMENT BONDED PARTICLE BOARD



GO GREEN with VIVA BOARD

VIVA Board is a cement bonded particle board. It conforms to the Thai Standard TIS. 878-2537 for cement bonded particle board quality requirements and the European Standard EN 13986:2004 for wood-based panels use in construction.

VIVA Board also complies with Green Material Schemes such as Thai Green Label and Singapore Green Label. It proves to be both health and environmentally friendly building material.

VIVA Board is manufactured by Viva Industries Co., Ltd. The company is certified by the quality management system ISO 9001, the environmental management system ISO 14001 and ISO 45001

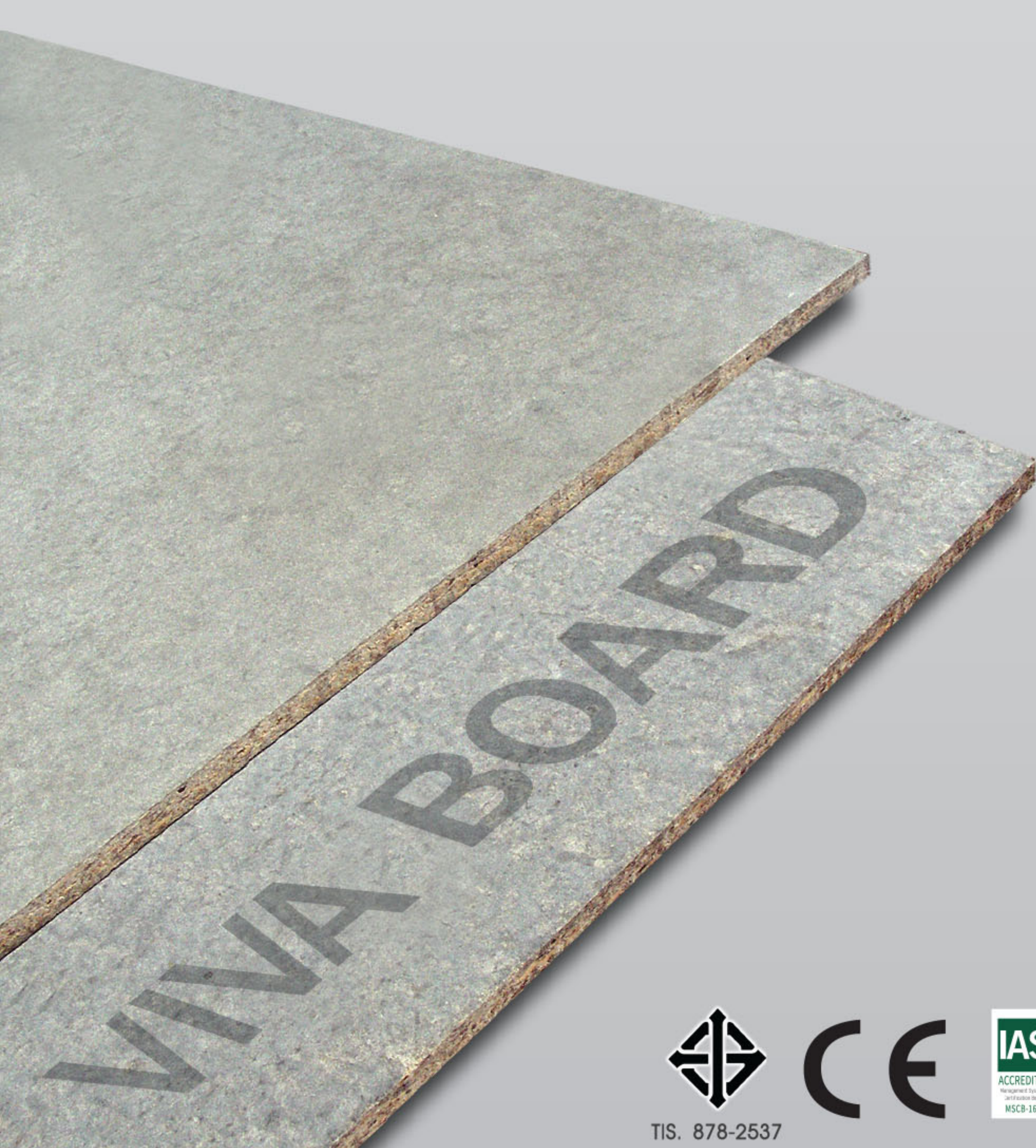

TIS. 878-2537

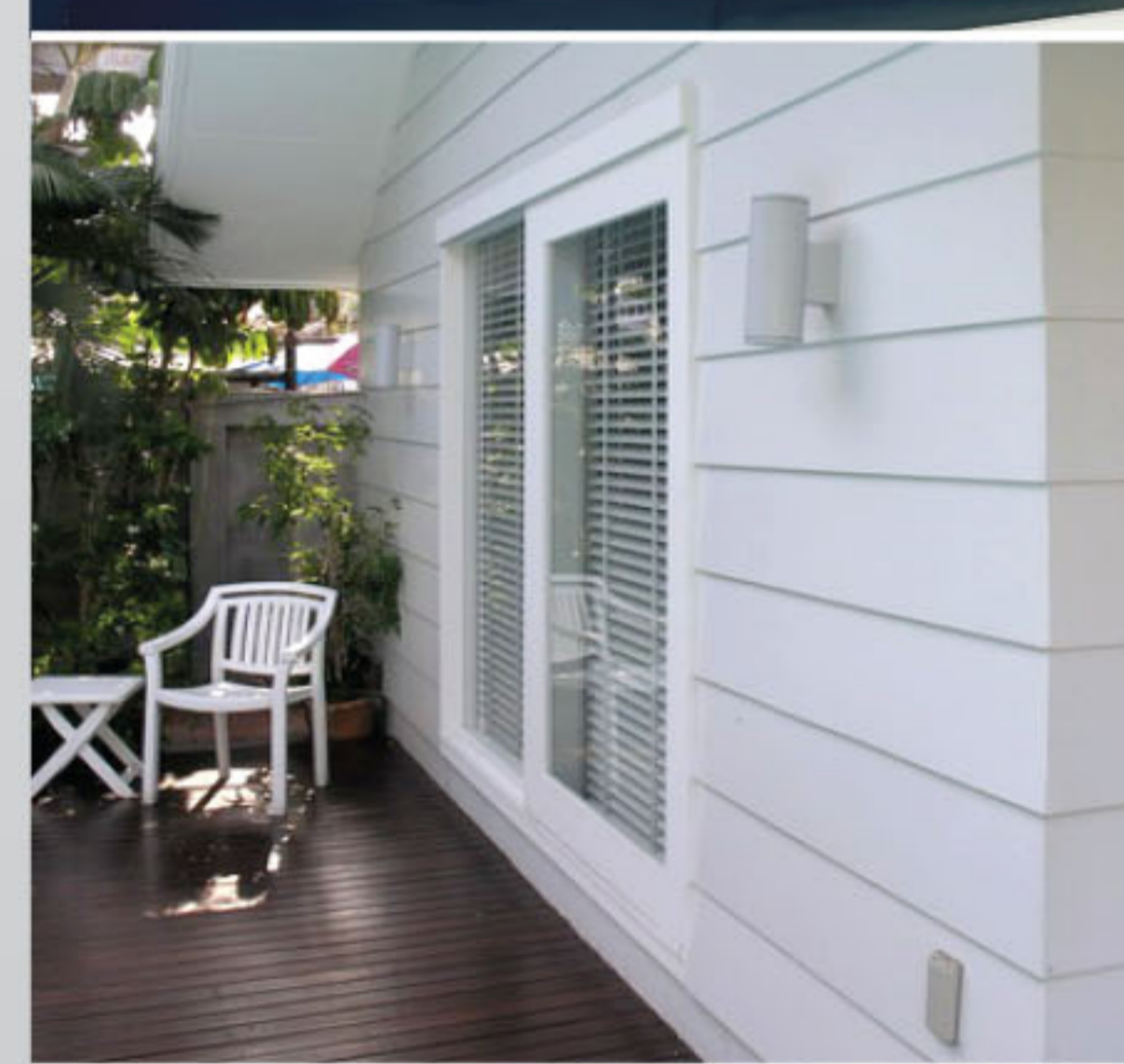
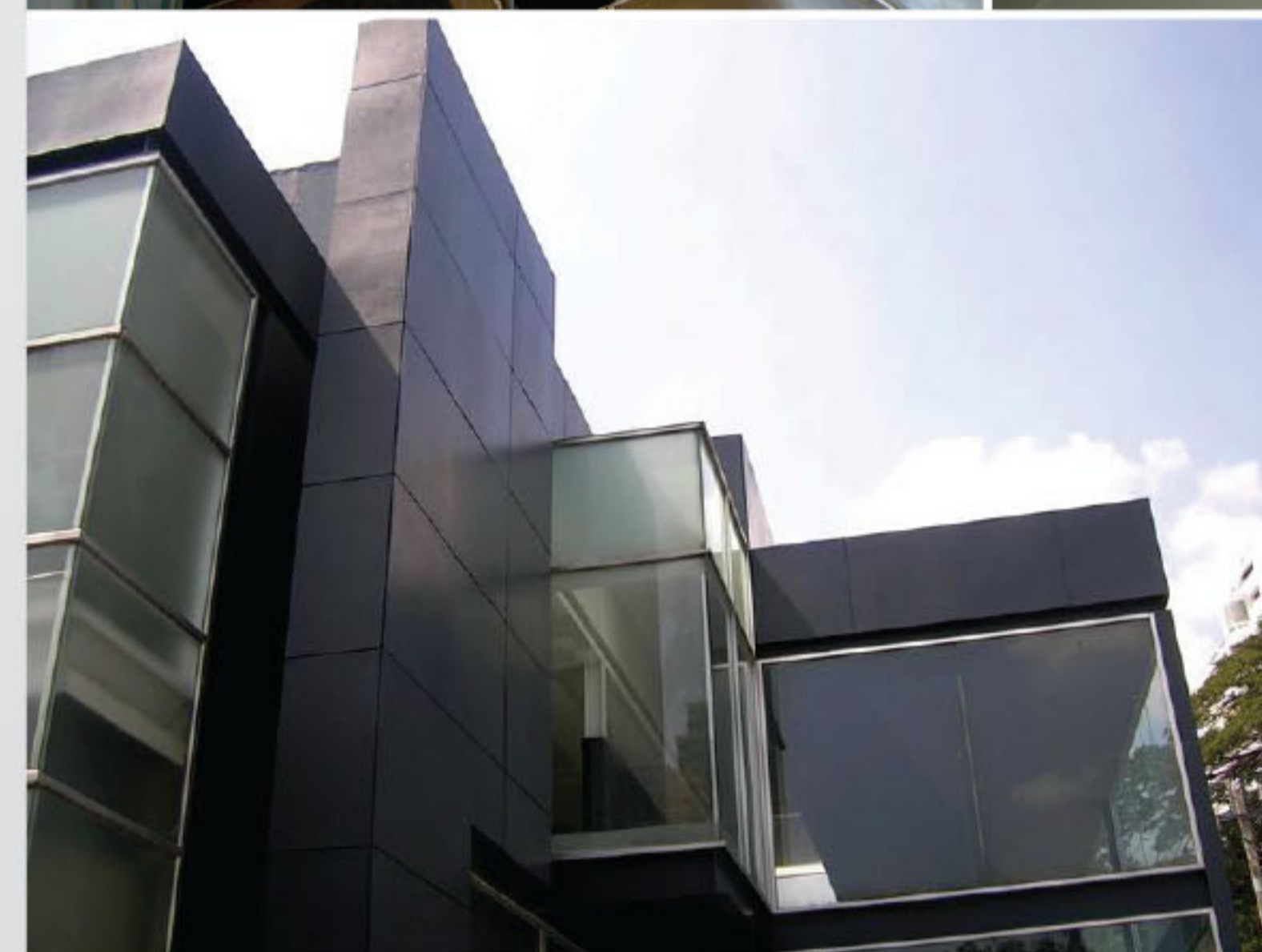
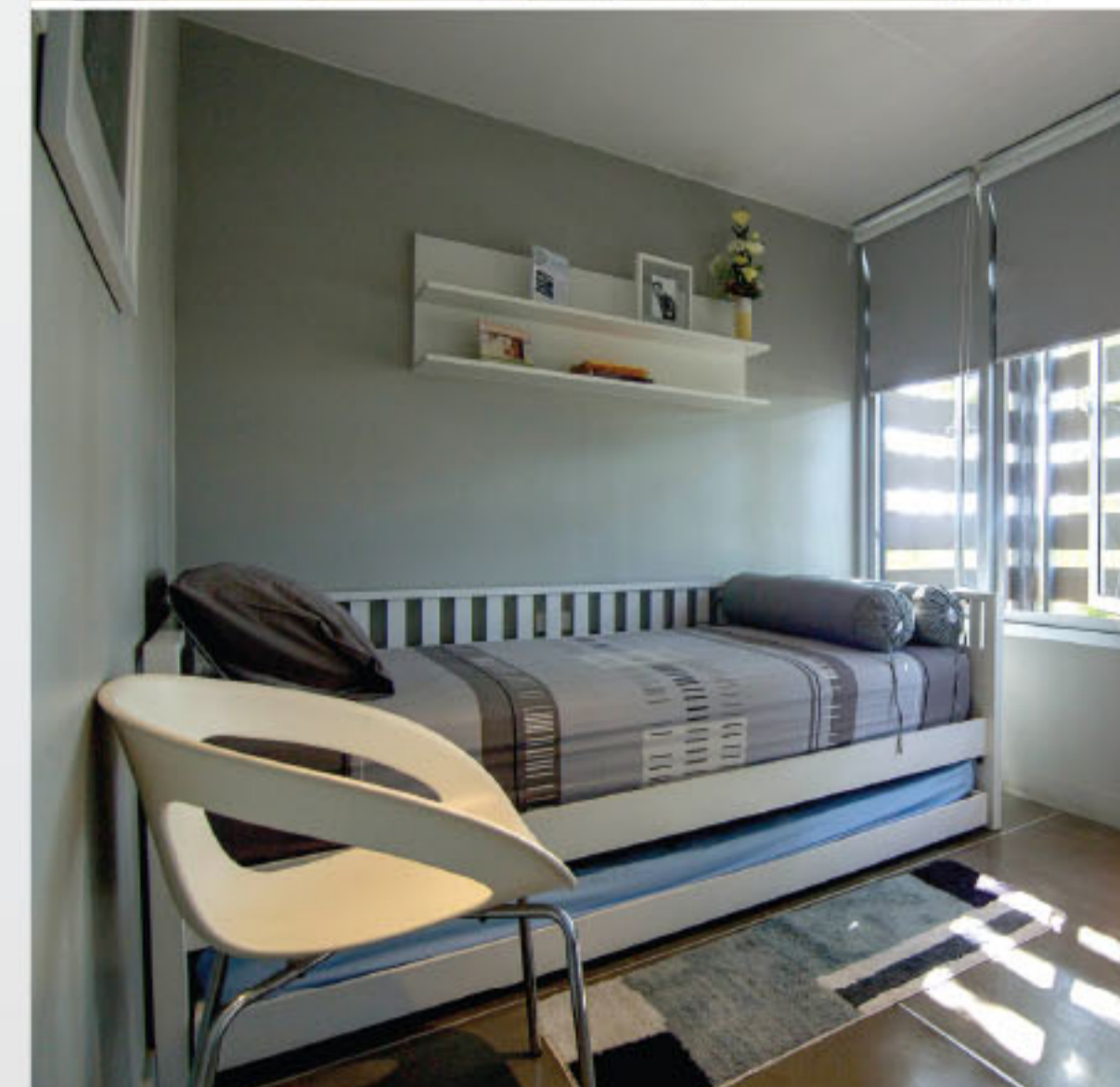

World Class Projects

With 30 years of experience, plus constant research and development, VIVA Board has been proven to be a superior cement-bonded particle board, and has been used in many world-class construction projects.

World class projects that entrust VIVA Board



Singapore Sport Hub



The Venetian, Macao



Yas Island, Abudhabi



Ruby hall, Myanmar



Naypyidaw Airport, Myanmar



Marina Bay Sand, Singapore



Resort World Sentosa, Singapore



Dubai Mall, Dubai



Changi Airport, Singapore



Dubai Festival City, Dubai



VIVA BOARD



VIVA BOARD

THE BEST COMBINATION OF WOOD AND CEMENT

VIVA Board is a cement bonded particle board. It has unique smooth grey cement surface. It is made from planted Eucalyptus chips, Portland cement, and mineralizing agents. Wood is processed into coarse and fine flake and thoroughly mixed with cement, mineralizing agent, and water in computer-controlled mixer. The required amount of mixed material is laid continuously on carrier plates using unique process which distributes coarse material in the middle and fine material on the two surfaces. The carrier plates with the formed mat are stacked and compressed using very high pressure to convert the formed mat into boards of required thickness with high strength and grey, smooth, cement-like surfaces. Once the boards are cured and conditioned, they are trimmed to the finished size, thoroughly inspected for quality, and packed for dispatch.

Size, Thickness and Weight



	Standard Size (mm)	1200 x 2400 and 1220 x 2440					
	Thickness (mm)	8	10	12	16	20	24
	Weight (kg/m ²)	10.4	13.0	15.6	20.8	26.0	31.2
	Special Size (mm)	1200/1220 x 3000					
	Special Thickness (mm)	6 / 18 / 28 / 30					

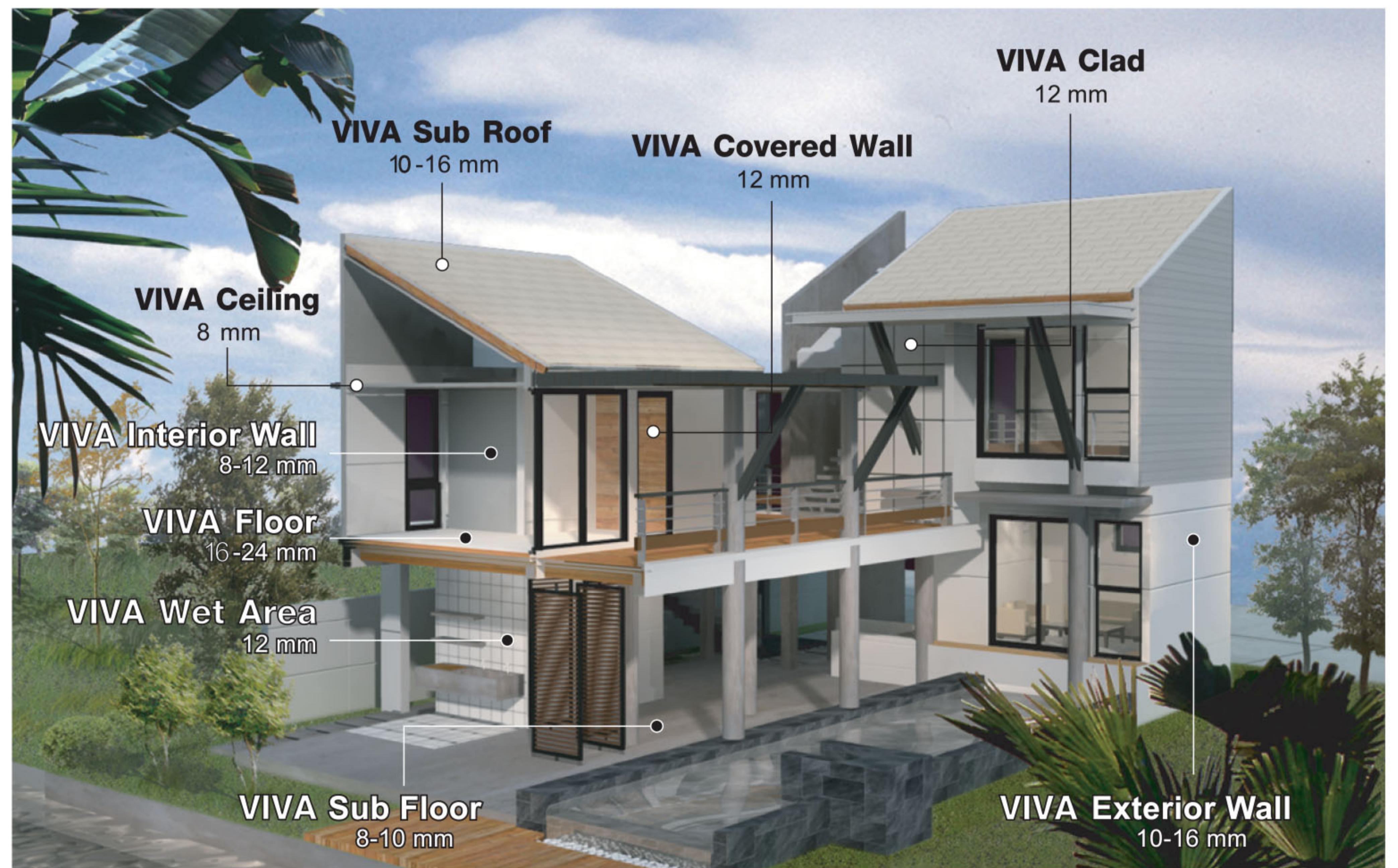

VIVA Thickness and Application

Application / Thickness (mm)	8	10	12	16	20	24
VIVA Clad (Exterior Cladding)			●			
VIVA Build: Residential Building Wall	●	●				
VIVA Build: Public Building Wall		●	●			
VIVA Easy Wall (Interior Wall or Partition)	●	●				
VIVA Covered Wall (Interior Wall with Covering Material)			●			
VIVA Deco Wall: Interior Wall in Natural Finish	●	●				
VIVA Deco Wall: Exterior Wall in Natural Finish				●		
VIVA Ceiling	●					
VIVA Sub Roof		●	●	●		
VIVA Wet Area (Tiled Wall)			●			
VIVA Sub Floor	●	●				
VIVA Floor				●	●	●

VIVA SOLUTION

VIVA DECOR

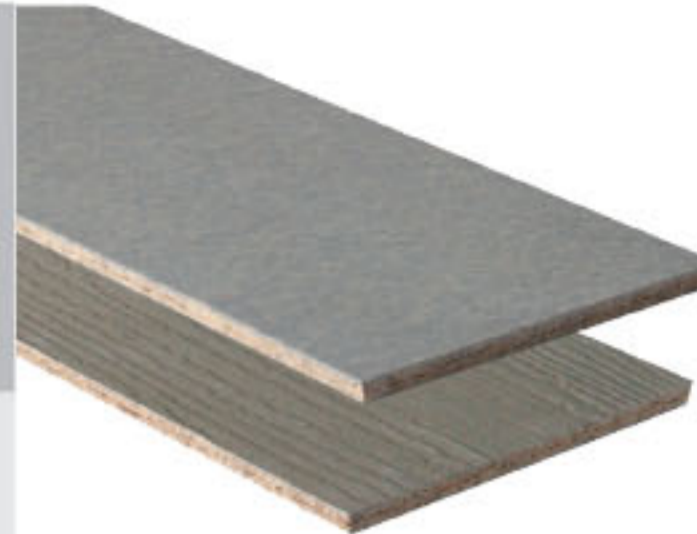

VIVA Fence

Pattern	Thickness (mm)	Width (mm)	Length (mm)
Classic	16	100 / 150	1000 / 1200
Wood Pattern			

VIVA Plank

Pattern	Thickness (mm)	Width (mm)	Length (mm)
Classic	30	200 / 300	2400
Wood Pattern			

Thickness (mm)

8, 10, 12, 16, 20, 24

Size (mm)

Stone Pattern: 1200 x 2400,
1220 x 2440

Wood Pattern: 1200 x 2400,
1220 x 2440



VIVA Clad

Exterior Cladding on Metal Structure or Existing Wall

VIVA Board:	12 mm
Installation Type:	Flex
Frame:	0.70 - 1.00 mm galvanized top hat section
Frame Spacing:	@ 40-60 cm
Fixing:	On top hat section
Finishing:	Acrylic paint
Instruction:	Fix Top hat section on existing wall or metal structure with spacing 0.60 m.

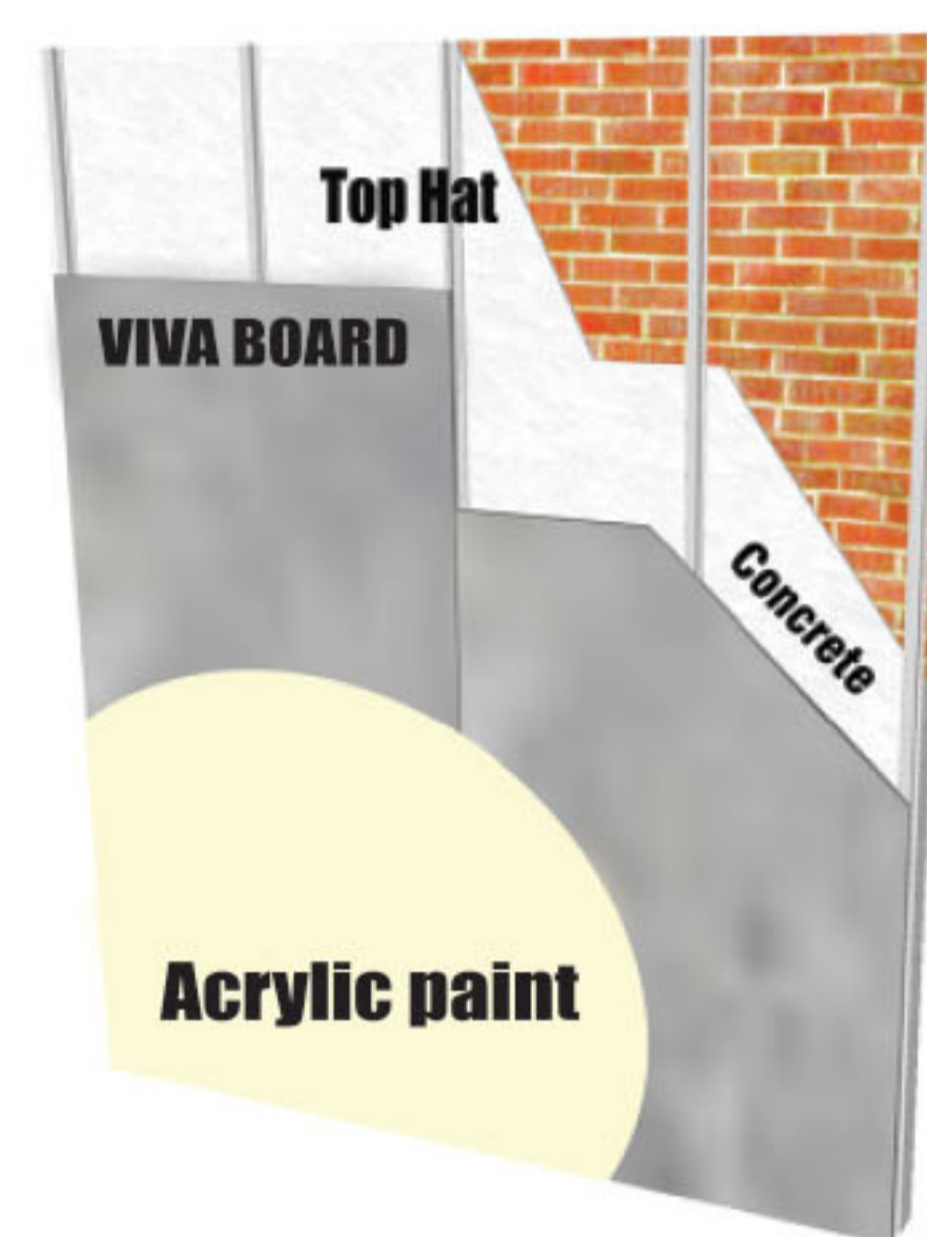

VIVA Build

Flex Installation					
Building Type	Height	VIVA Board		Frame	
		Interior	Exterior	Size	@
Residential	Below 6 m	8 mm	10 - 12 mm	C75, 0.50 mm thick	40 cm
	6 - 10 m		12 mm	C75, 0.75-1.00 mm thick	60 cm
Public Building	Below 10 m	10 mm	12 mm	C75, 0.75-1.00 mm thick	60 cm
	10 - 20 m		12 - 16 mm		40 cm

Fixing: On principal studs
Finishing: Acrylic paint

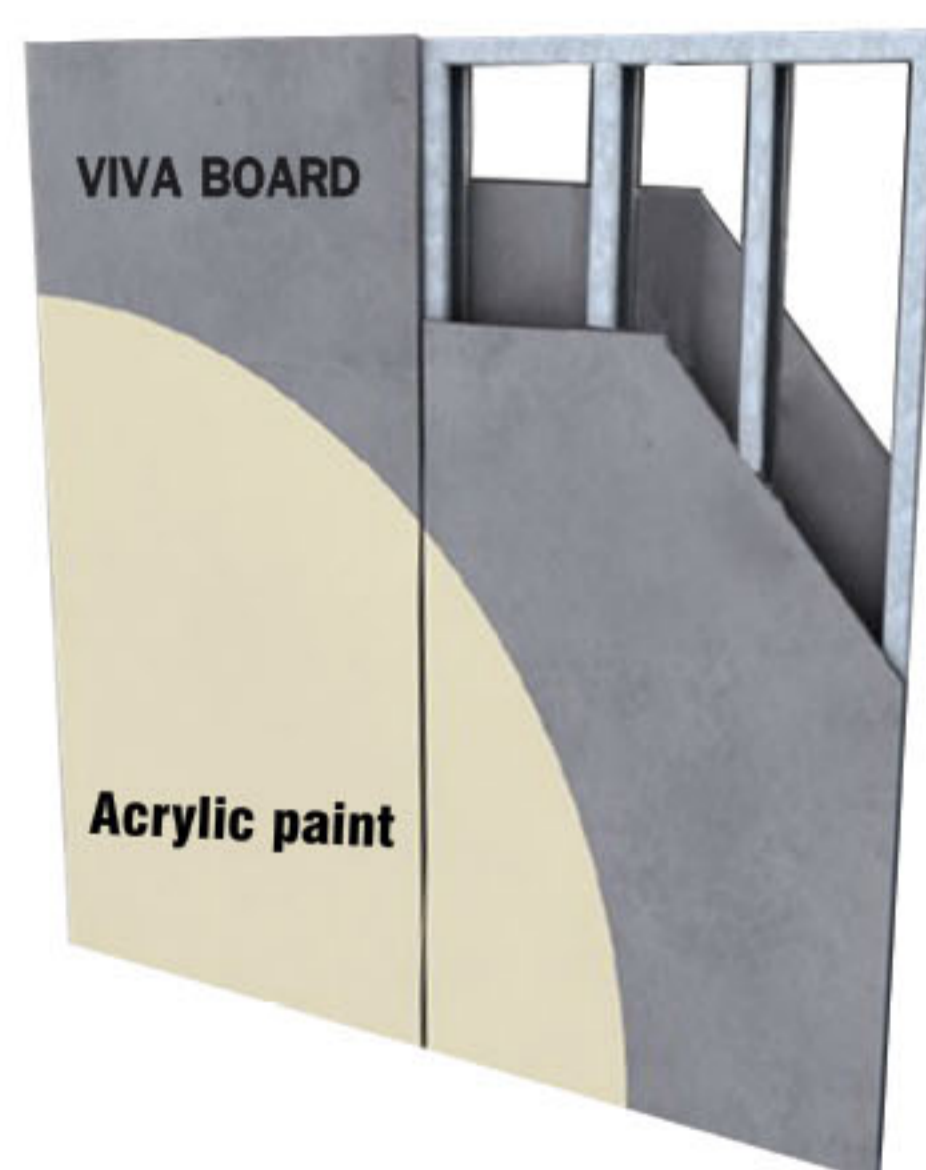

Wind Load Table		
Wind Load	Building Height: 0 - 10 m	Building Height: 10 - 20 m
VIVA Board Thickness (mm)	Wind Load (kg/m ²)	Wind Load (kg/m ²)
	50	80
	Stud Spacing (cm)	Stud Spacing (cm)
10	40	-
12	60	40
16	60	60

Remark: For buildings over 20 meters height, please consult manufacturer.

VIVA Easy Wall

Interior Wall or Partition

VIVA Board:	8-10 mm
Installation Type:	Flex
Frame:	Galvanized steel C and U section, 0.50 mm thick
Frame Spacing:	@ 60 x 240 cm
Fixing:	On principal studs
Finishing:	Acrylic paint

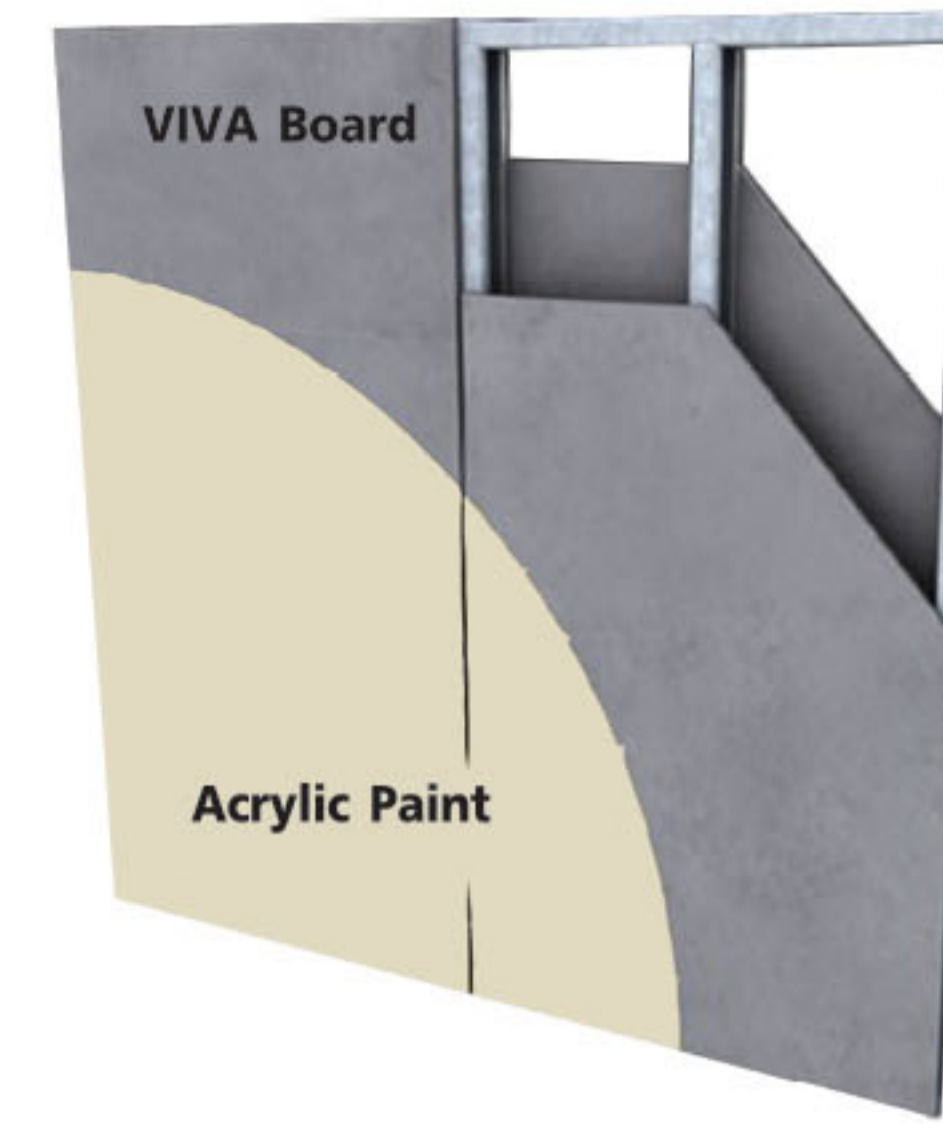

VIVA Covered Wall

Interior Wall with Covering Material

VIVA Board:	12 mm
Installation Type:	Firm
Frame:	Galvanized steel C section 0.75 mm and U section 0.50 mm thick
Frame Spacing:	@ 60 x 60 cm
Fixing:	On principal and common studs
Control Joint:	At every 4.8-6 m. and corners of the room
Finishing:	Wallpaper, Ceramic tile
Instruction:	<ul style="list-style-type: none"> • Bond boards together using epoxy glue to minimize movement • Attach covering material on board according to its installation guide • Fill joint of ceramic tile with tile grout except joint over board's joint fill with polyurethane sealant • Tiling over board's joint and control joint are not recommended

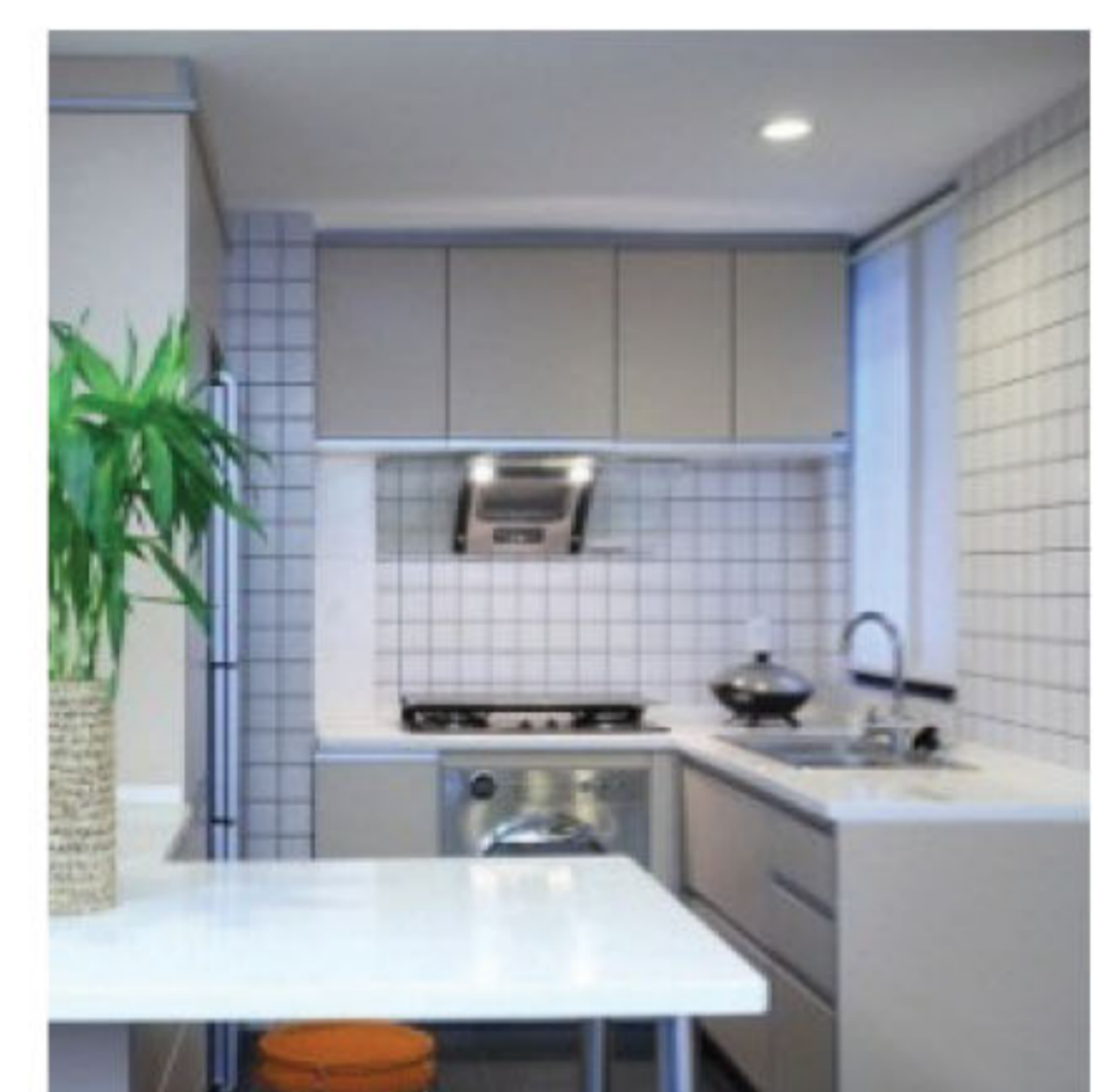
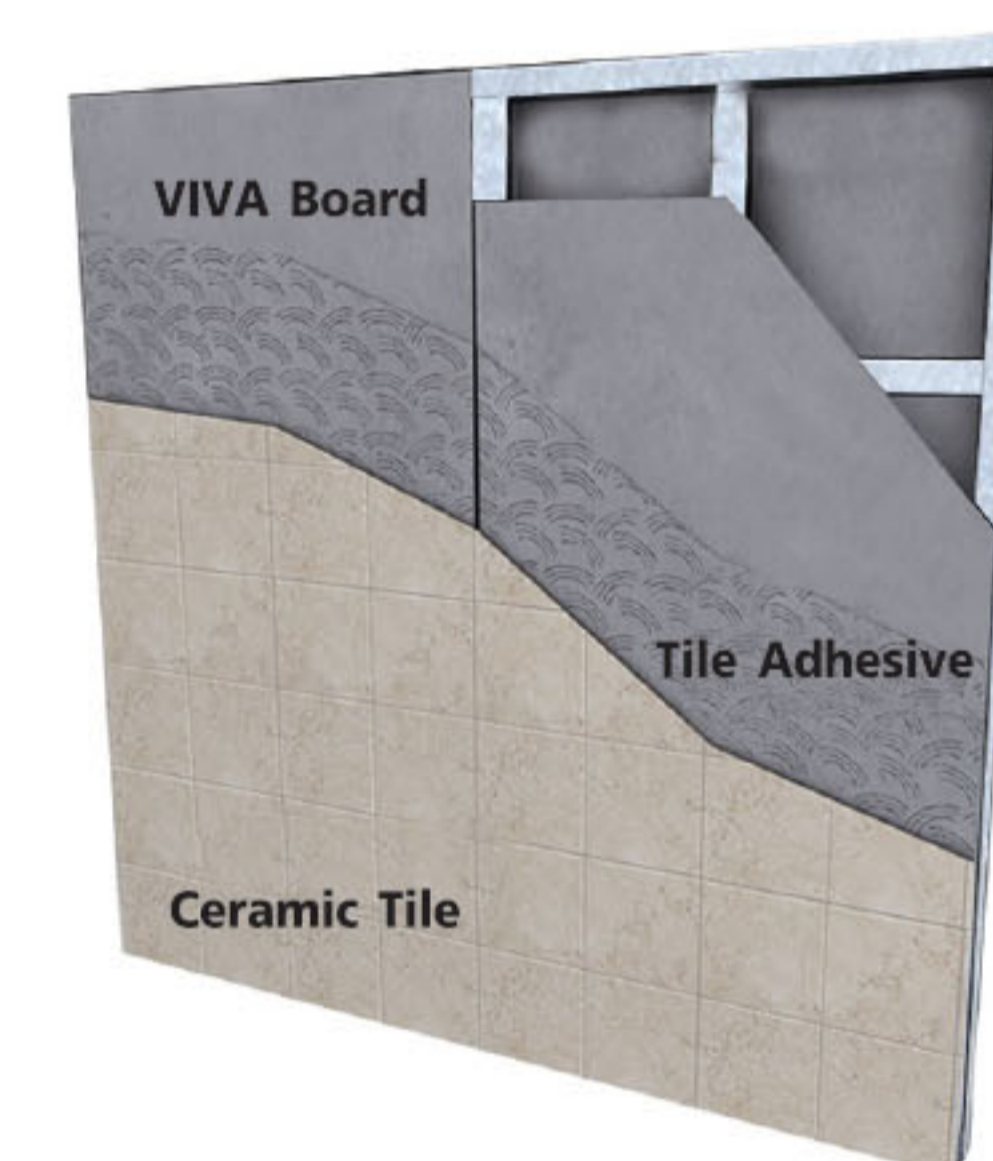

VIVA Combi Wall

Smooth Finish Interior Wall

(Non-Fire-Rated and 90 Minutes Fire-Rated)

VIVA Board:	8 mm
Installation Type:	Firm
Frame:	Galvanized steel C64 and U66 section 0.50 mm thick for non-fire-rated partition and Galvanized steel C75 and U76 section 0.50 mm thick for 90 minutes fire-rated partition
Gypsum Board:	9 mm Gypsum board for non-fire-rated partition 15 mm fire-rated Gypsum board for 90 minutes fire-rated partition
Frame Spacing:	@ 60 x 240 cm
Fixing:	On principal and common studs
Control Joint:	At every 4.8-6 m. and corners of the room
Finishing:	Acrylic paint
Instruction:	<ul style="list-style-type: none"> • Fix recommended Gypsum board over both sides of VIVA board in staggered pattern. • Joint of VIVA board and Gypsum board must not overlap.

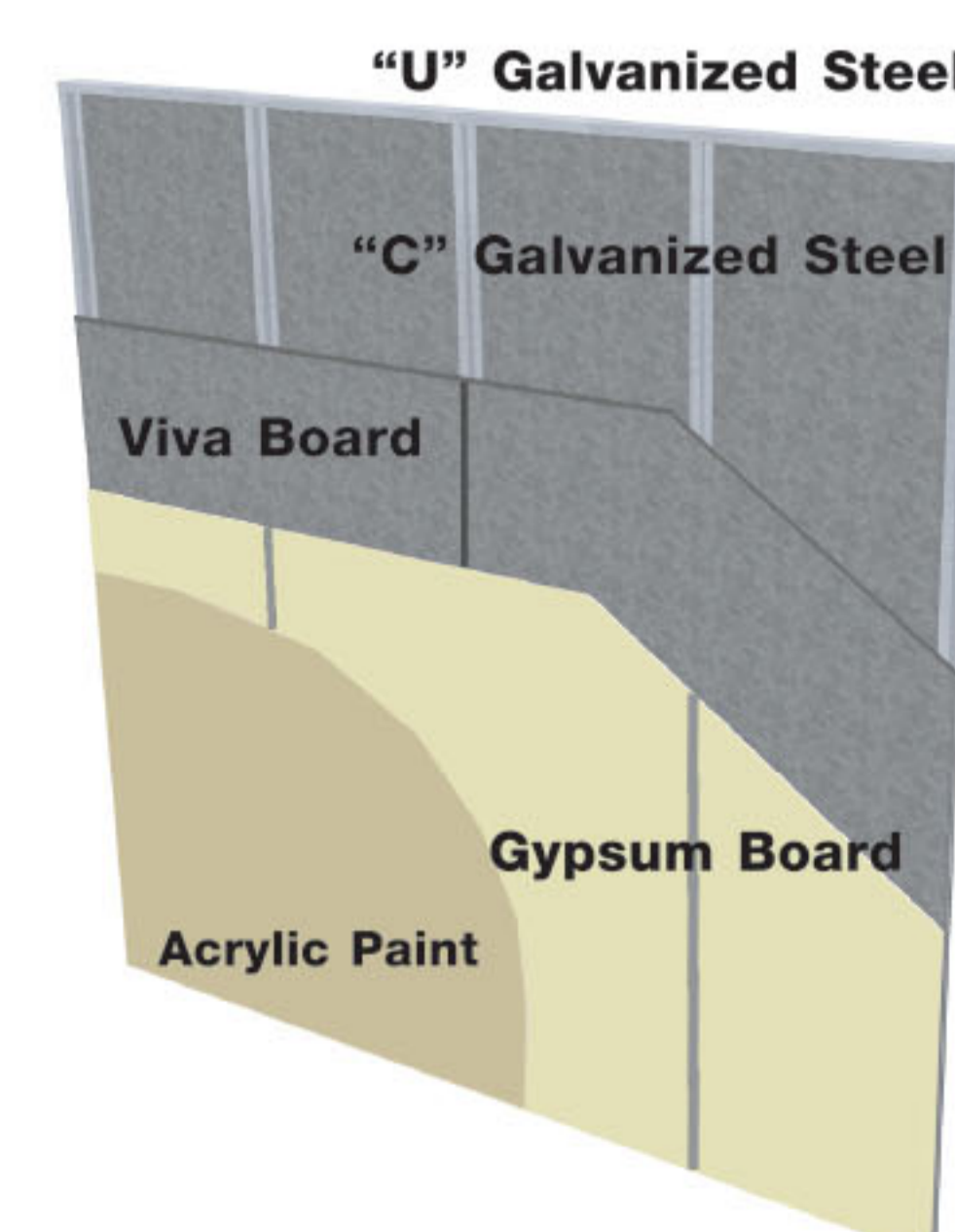

VIVA Deco Wall

Interior Wall in Natural Finish

VIVA Board:	8 - 10 mm
Installation Type:	Flex
Frame:	Timber frame 1 1/2 "x 3"
Frame Spacing:	@ 60 x 60 cm
Fixing:	On principal studs
Finishing:	Lacquer, gloss/matte polyurethane



Exterior Wall in Natural Finish on Metal Structure or Existing Wall

VIVA Board:	16 mm
Installation Type:	Flex
Frame:	0.70 - 1.00 mm galvanized top hat section
Frame Spacing:	@ 40-60 x 240 cm
Fixing:	On top hat section
Finishing:	Gloss/matte polyurethane
Instruction:	Fix Top hat section on existing wall or metal structure with spacing 0.60 m.

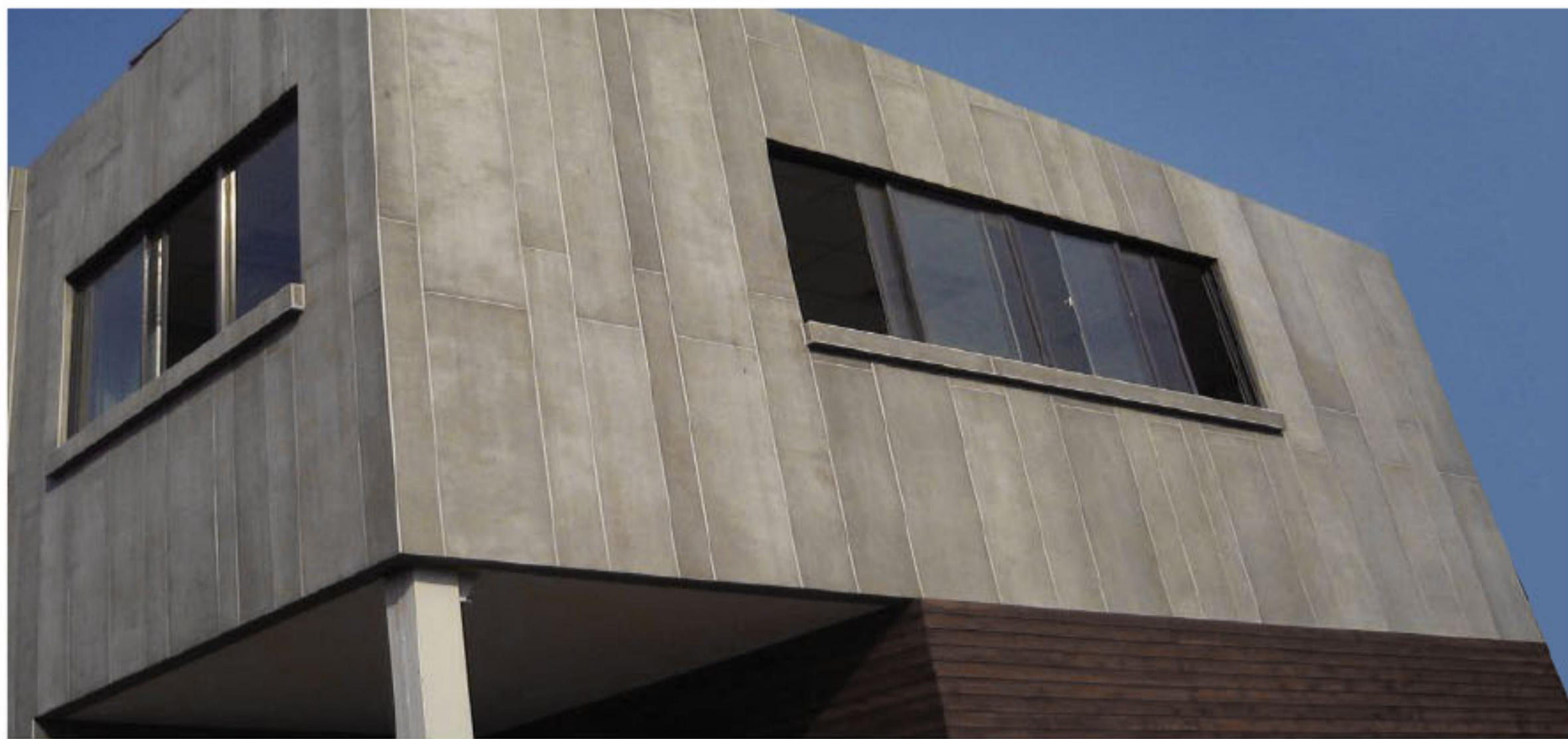
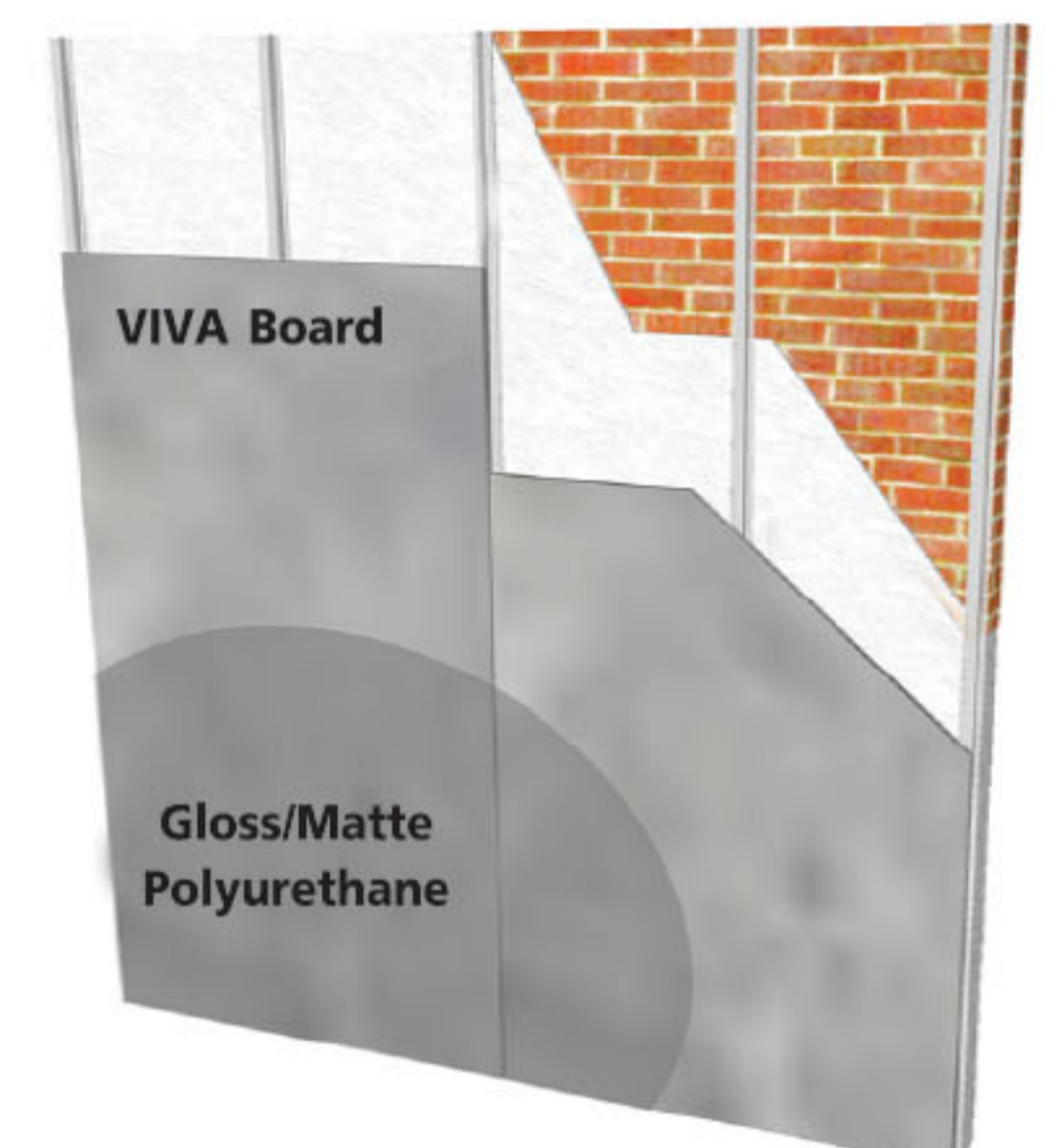
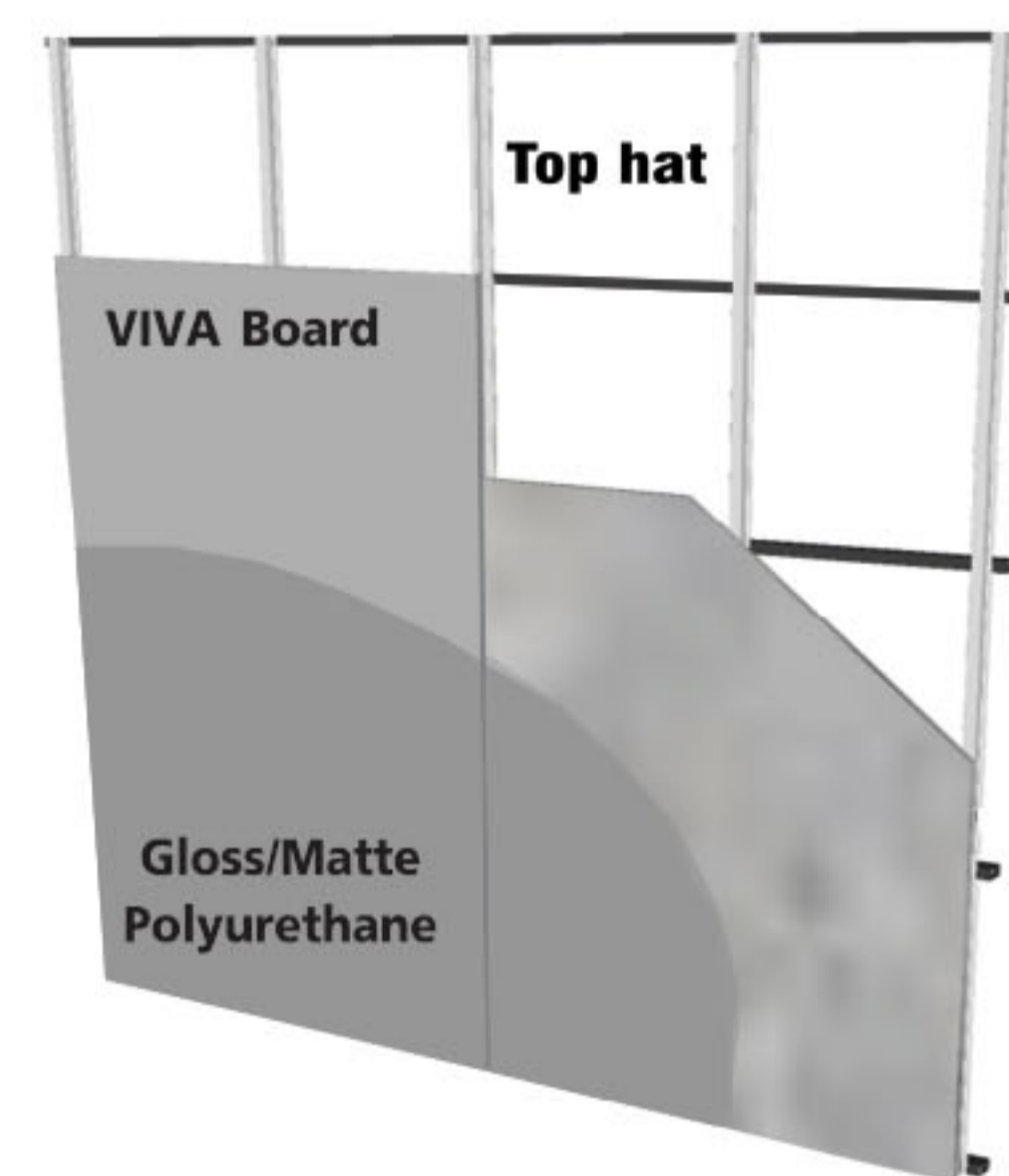

VIVA Deco Floor

Interior Floor in Natural Finish

VIVA Board:	16 - 24 mm
Installation Type:	Flex
Frame:	Light gauge C section, 2.3-3.2 mm thick
Frame Spacing:	@ 40-60 x 120 cm
Fixing:	On principal joists
Finishing:	Gloss/matte polyurethane or epoxy

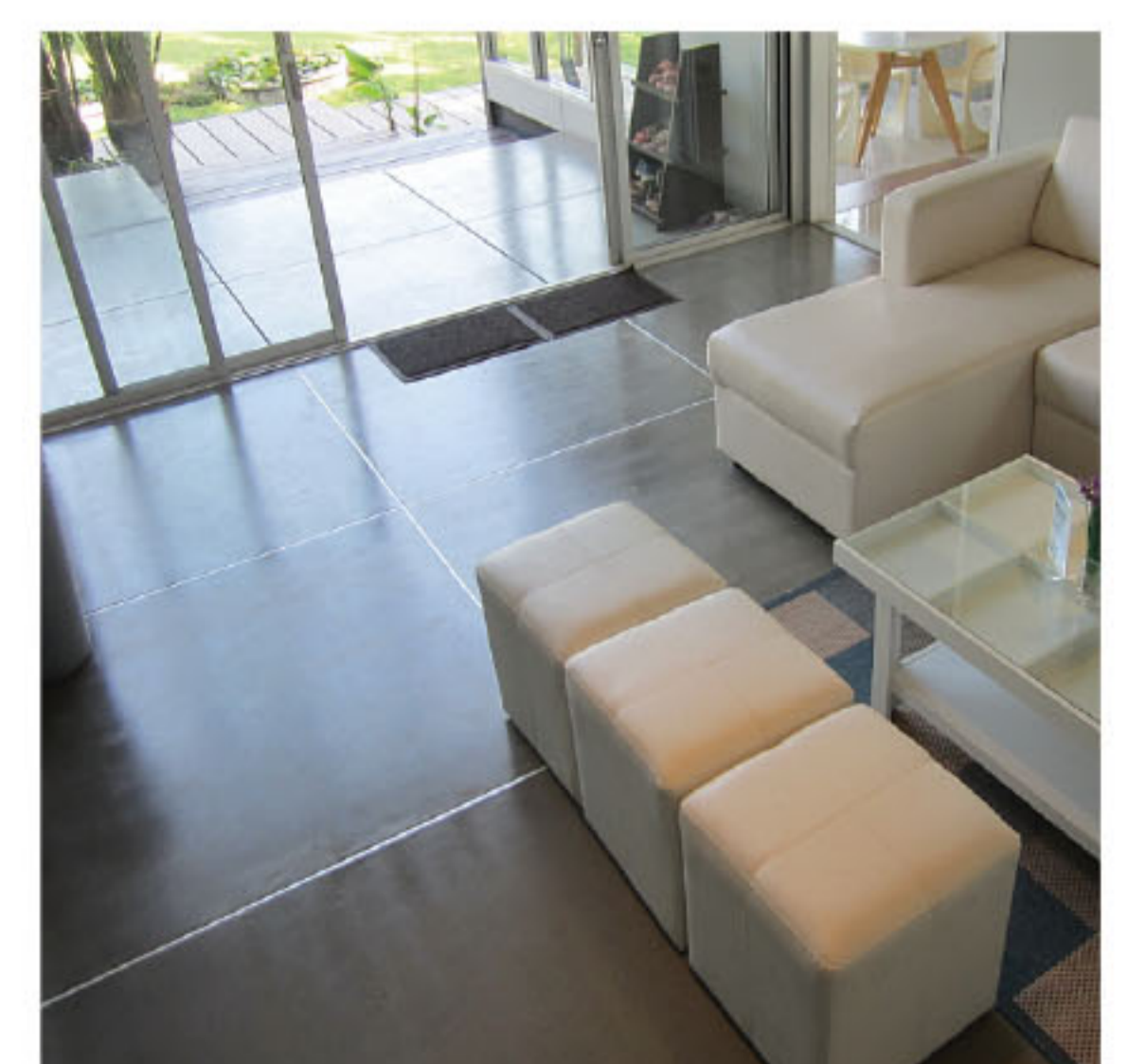
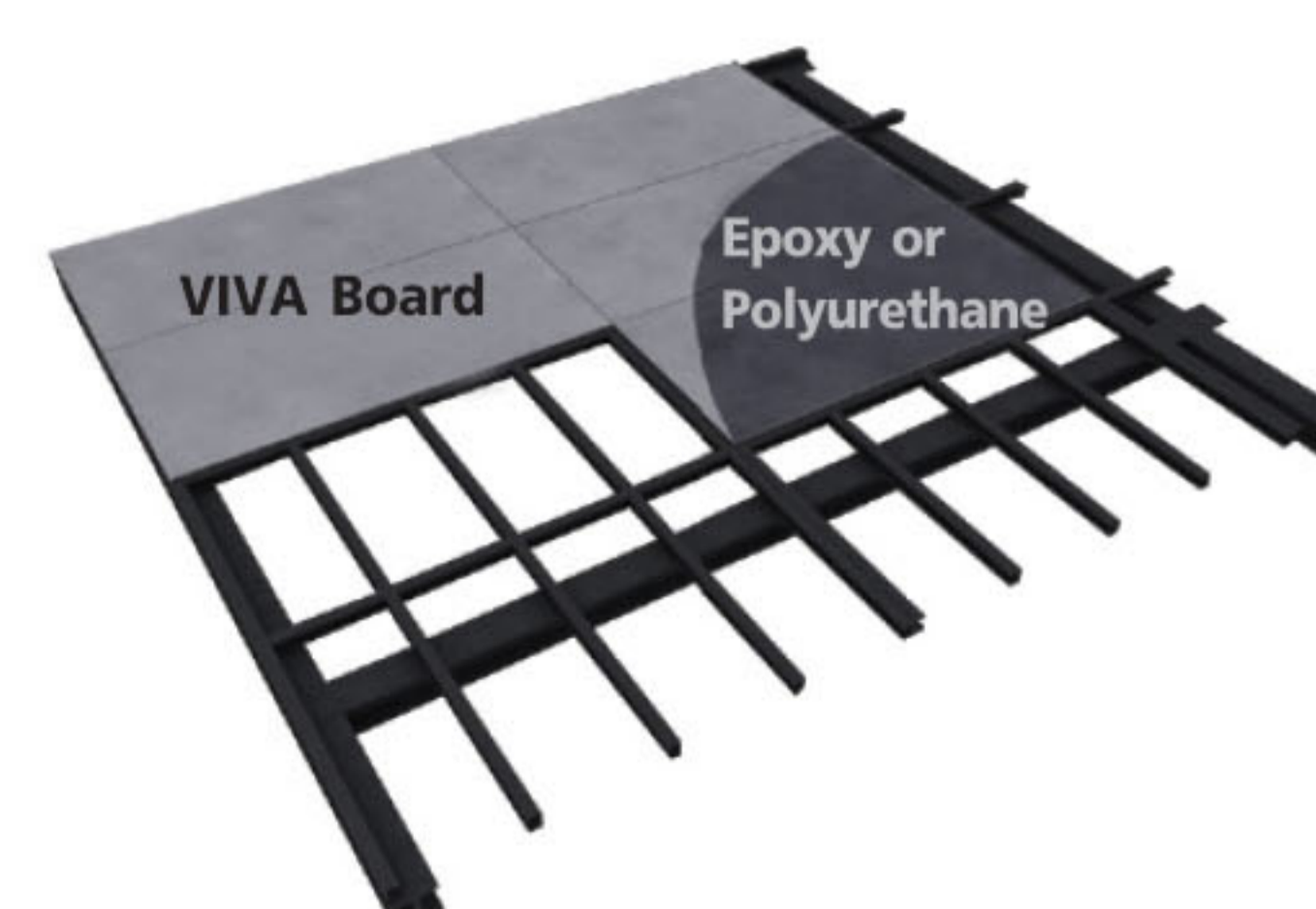

VIVA Wet Area

Tiled Wall

VIVA Board:	12 mm
Installation Type:	Firm
Frame:	Galvanized steel C section 0.75 mm and U section 0.50 mm thick
Frame Spacing:	@ 60 x 60 cm
Fixing:	On principal and common studs
Control Joint:	At every 4.8-6 m. and corners of the room
Finishing:	Ceramic tile
Instruction:	<ul style="list-style-type: none"> • Bond boards edges together using epoxy glue • Caulk control joints with polyurethane sealant • Attach ceramic tiles on boards using highly elastic cement based tile adhesive • Fill joints of ceramic tile with tile grout except joint over board's joint fill with polyurethane sealant • Tiling over board's joint and control joint are not recommended

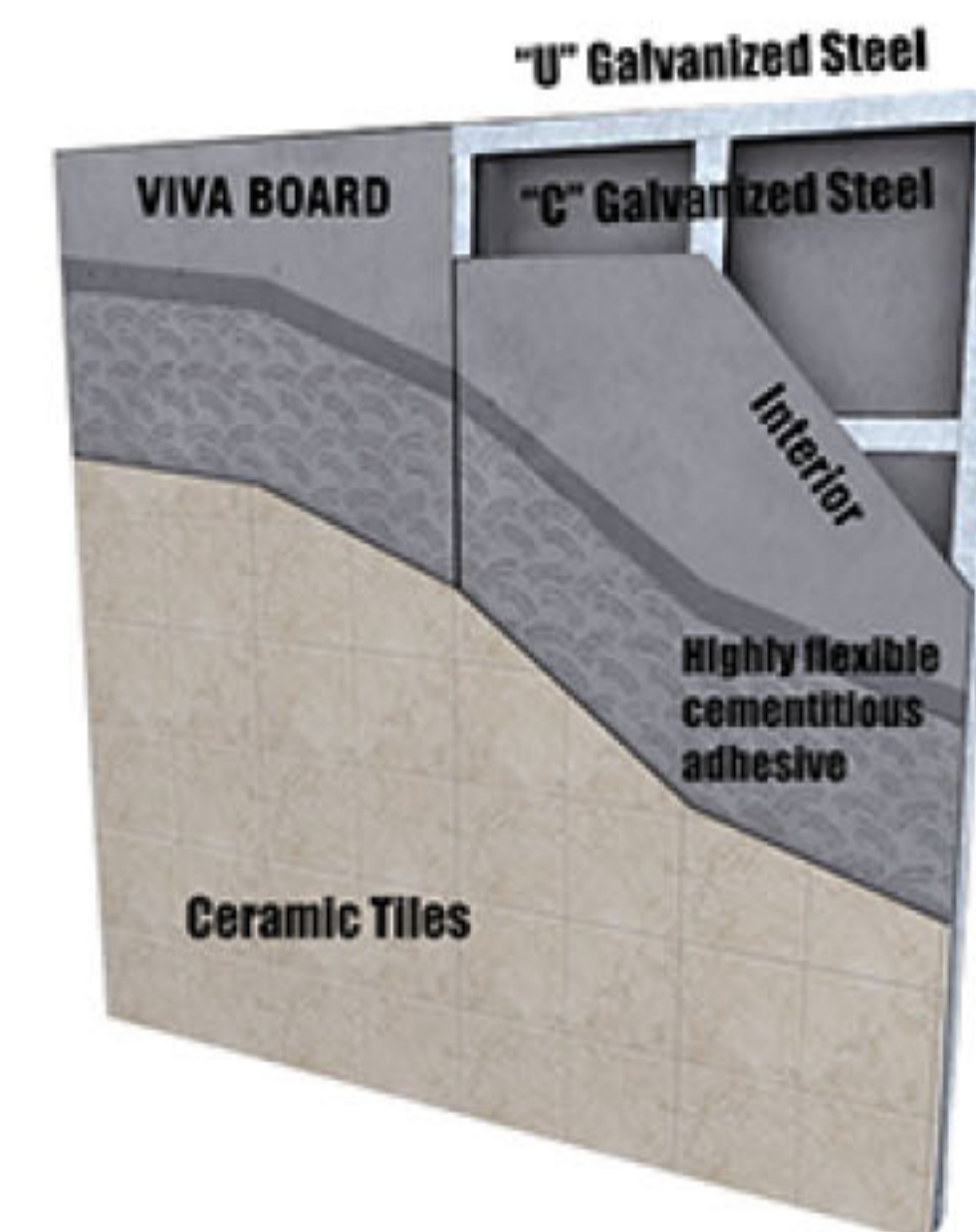

Tiled Floor

VIVA Board:	16 - 24 mm
Installation Type:	Firm
Frame:	Light gauge box section, 2.3-3.2 mm thick
Frame Spacing:	@ 40 x 40 cm to 60 x 60 cm depending on required loading capability
Fixing:	On principal and common joists
Control Joint:	At every 4.8-6 m. and corners of the room
Finishing:	Ceramic tile
Instruction:	<ul style="list-style-type: none"> • Lay boards in staggered pattern • Bond boards edges together using epoxy glue • Caulk control joints with polyurethane sealant • Lay water proofing membrane on VIVA board deck before laying ceramic tile • Attach ceramic tiles on boards using highly elastic cement based tile adhesive • Fill joints of ceramic tile with tile grout except joint over board's joint fill with polyurethane sealant • Tiling over board's joint and control joint are not recommended

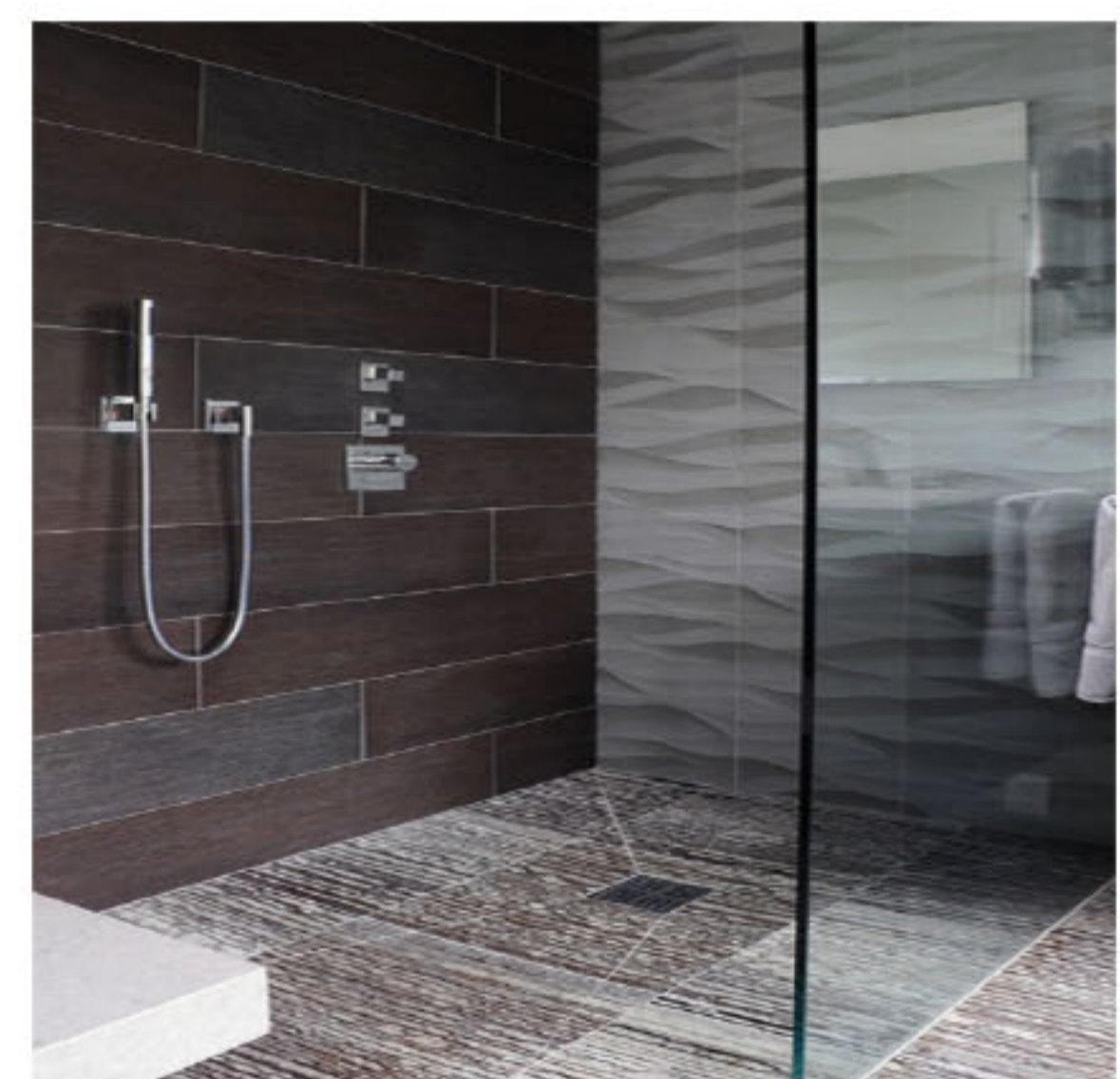
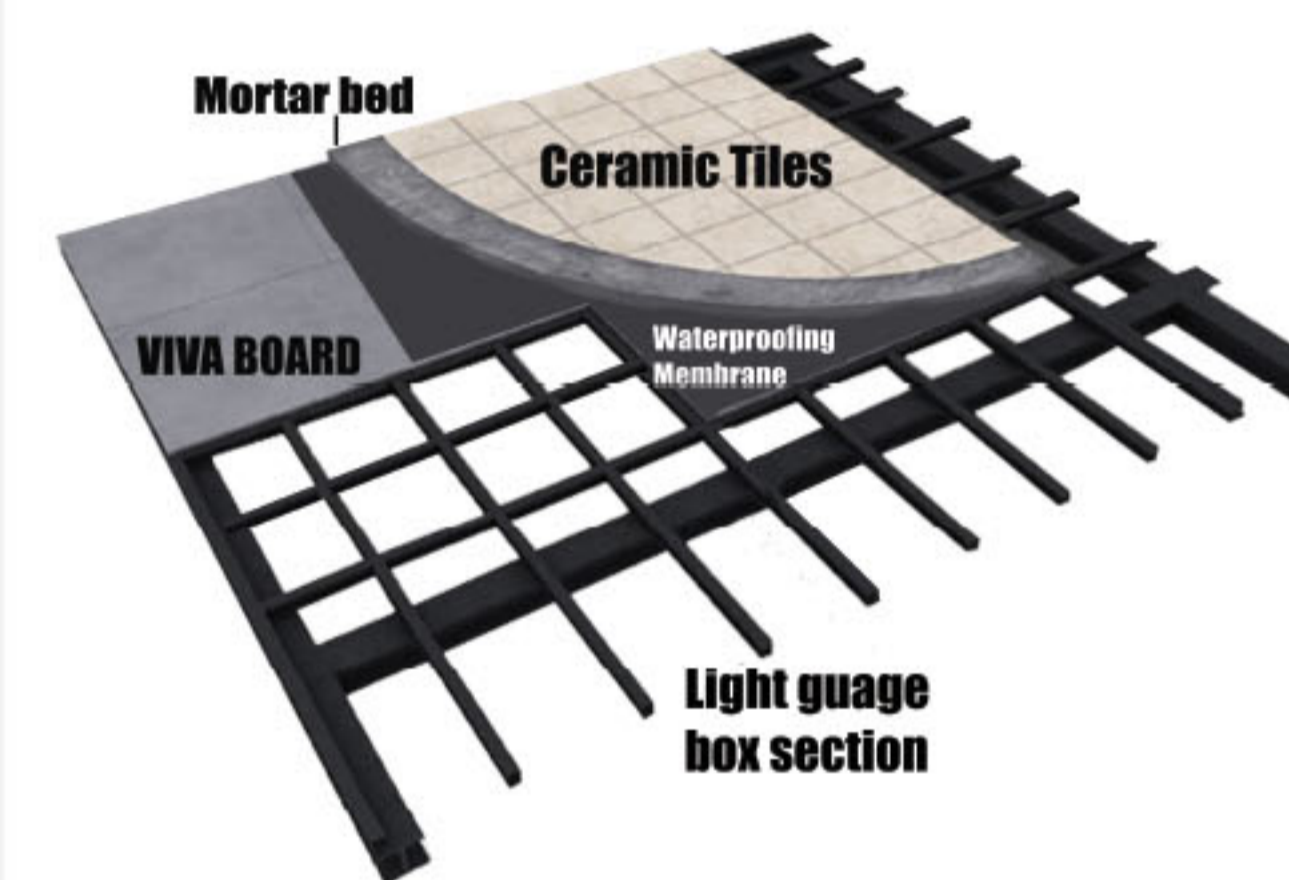

Special Applications

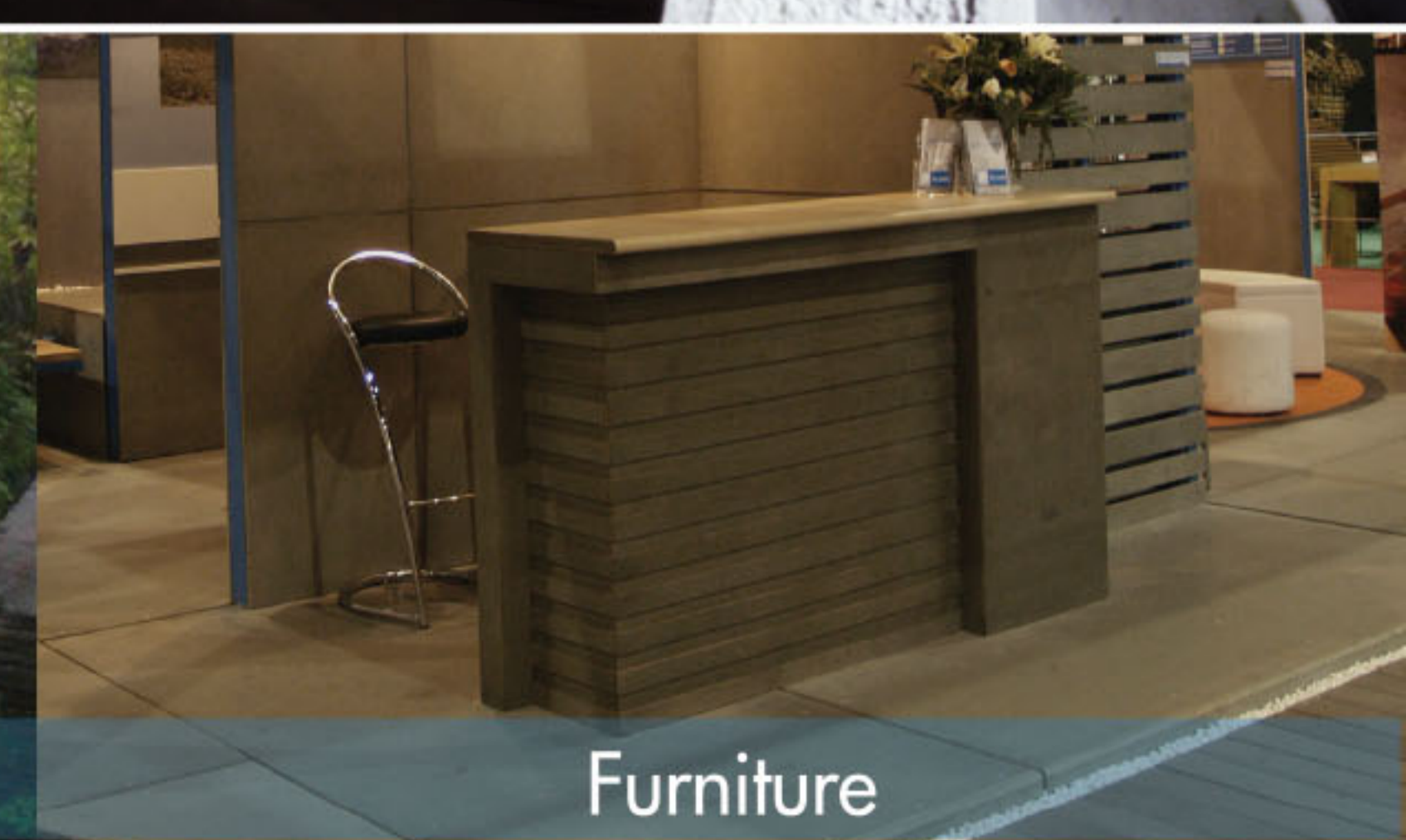
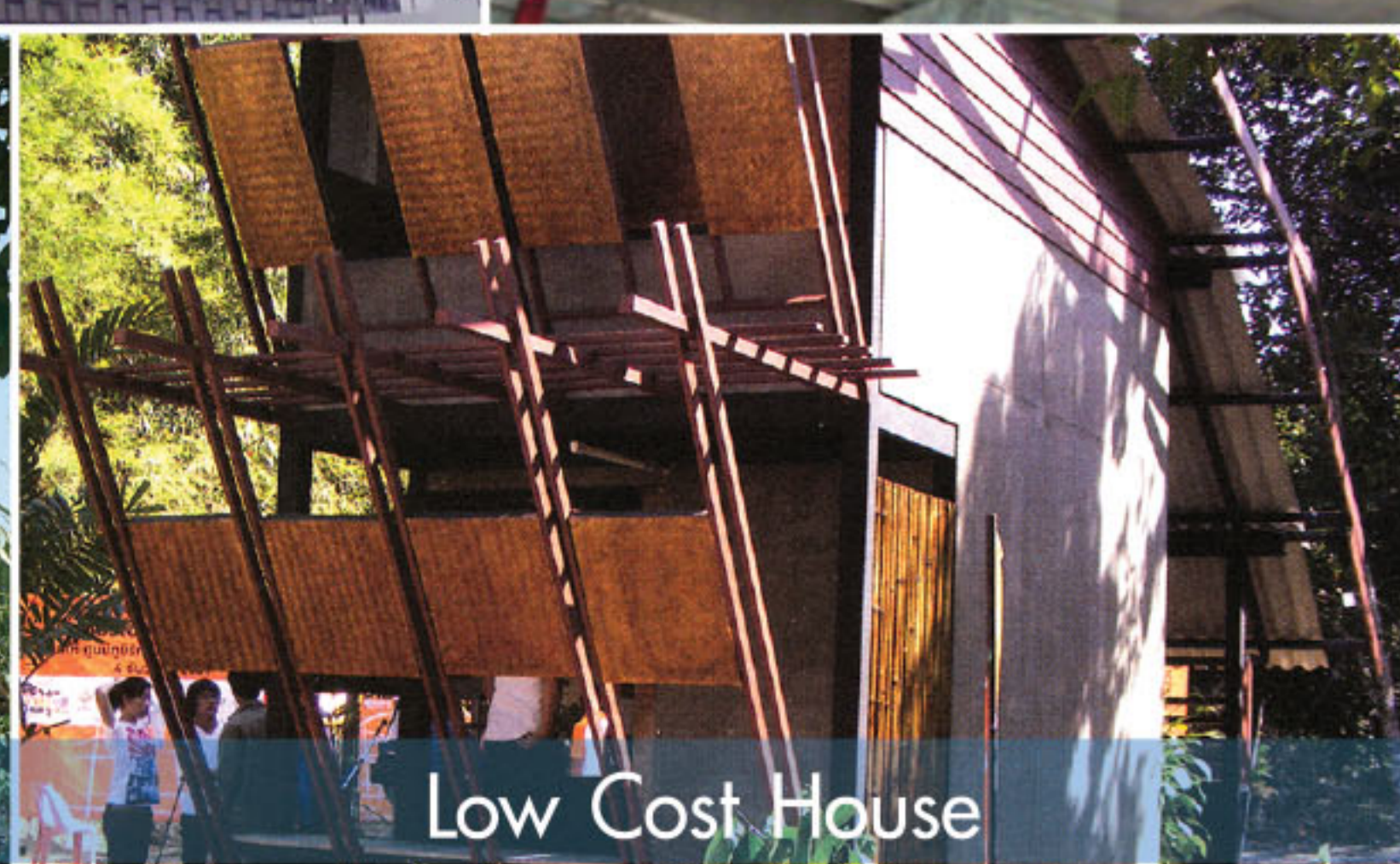

VIVA Floor

Elevated Floor & Mezzanine Floor with Covering Material

VIVA Board:	16 - 24 mm
Installation Type:	Firm
Frame:	Light gauge box section, 2.3-3.2 mm thick
Frame Spacing:	@ 40 x 40 cm to 60 x 60 cm depending on required loading capability
Fixing:	On principal and common joists
Control Joint:	At every 4.8-6 m. and corners of the room
Finishing:	Ceramic tile, PVC tile, Carpet
Instruction:	<ul style="list-style-type: none"> • Lay boards in staggered pattern • Bond boards edges together using epoxy glue • Caulk control joints with polyurethane sealant • Fix covering material on board according to its installation guide

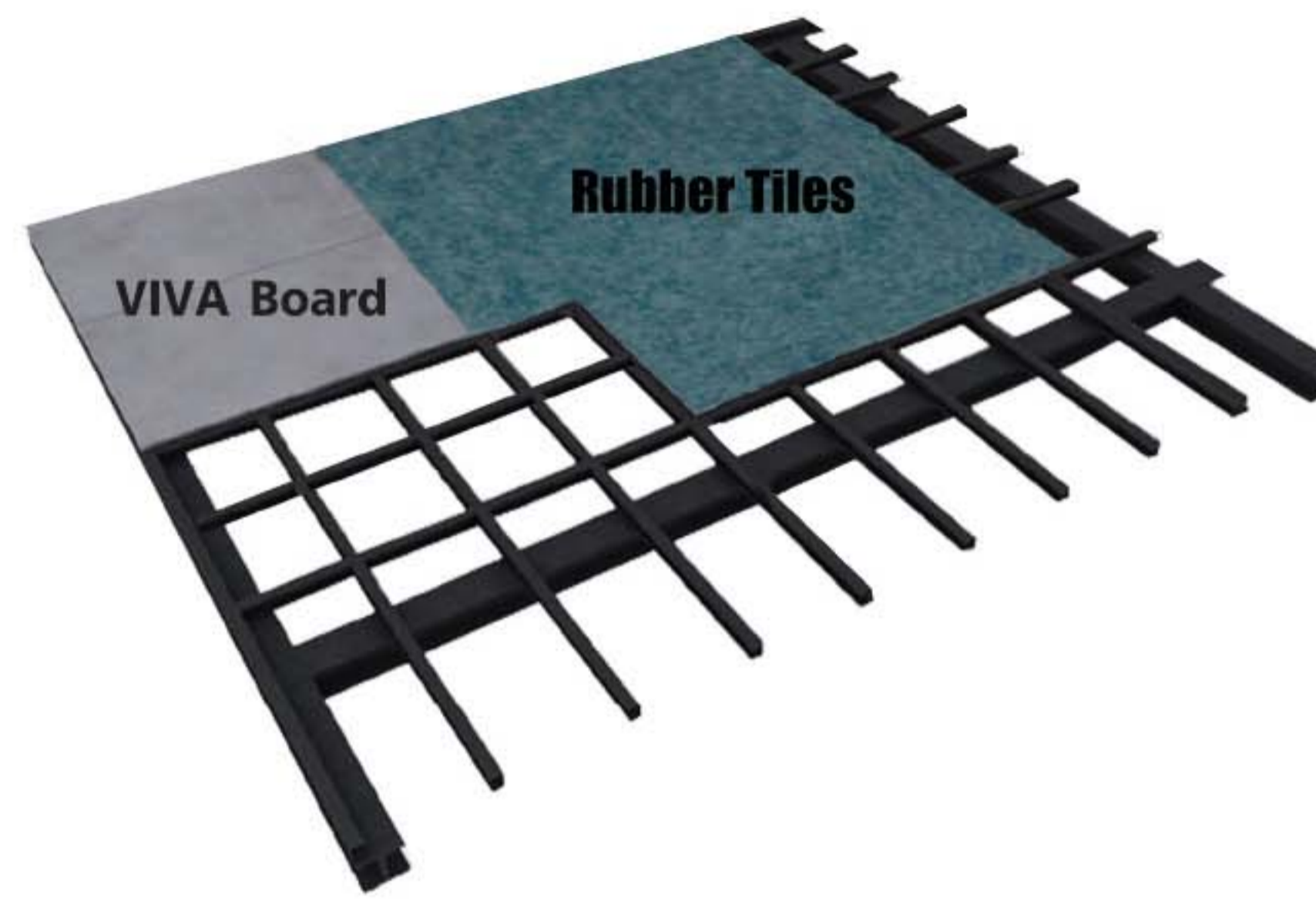
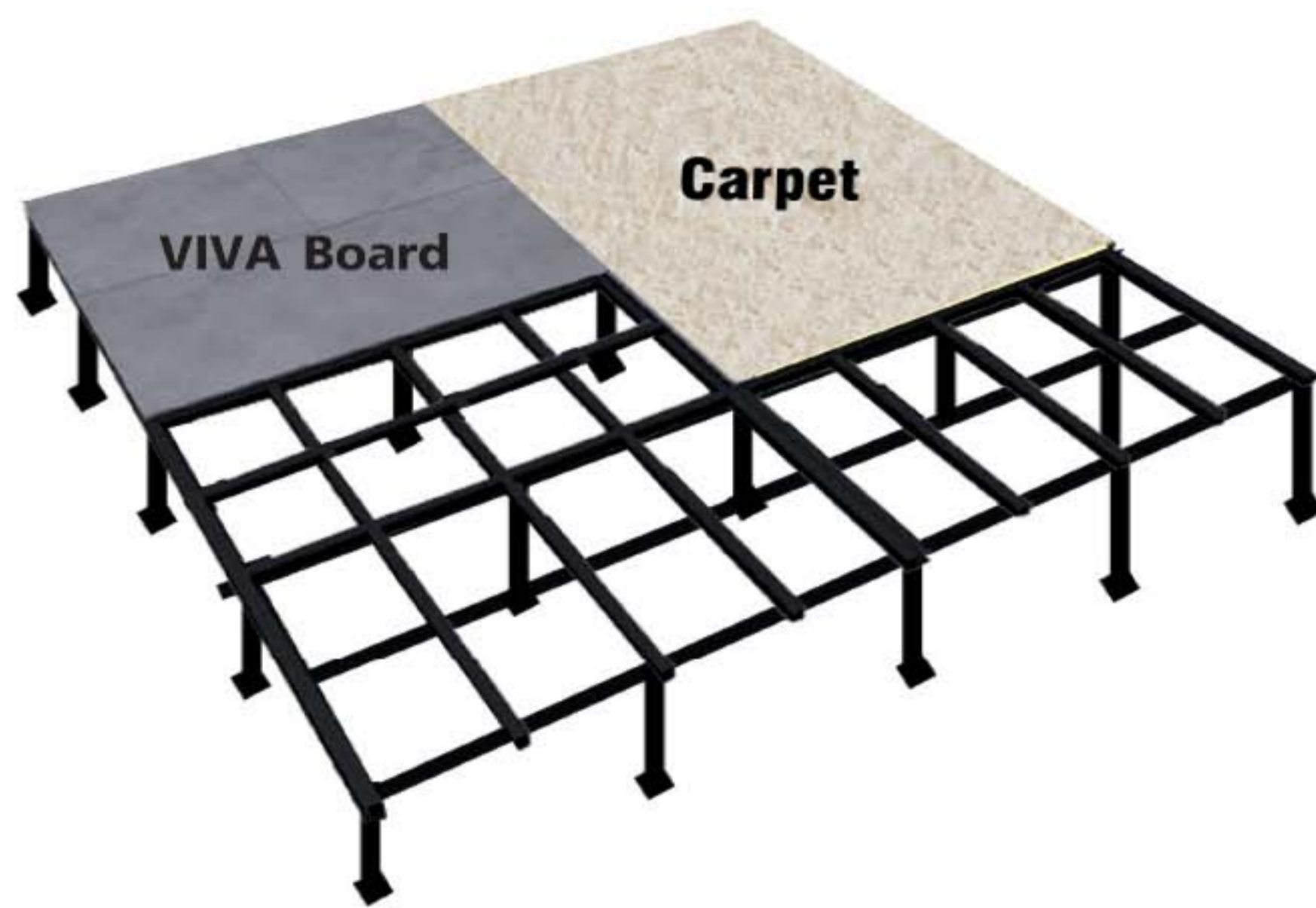

Sub Floor

VIVA Board:	8 - 10 mm
Frame:	Existing concrete floor
Finishing:	Wood flooring, parquet
Instruction:	<ul style="list-style-type: none"> • Spread polyurethane adhesive on back side of boards • Lay boards in staggered pattern • Fix boards to concrete floor with 2" concrete nail at every 20 cm • Lay water or sound proofing membrane on VIVA board deck • Fix wood flooring or parquet on boards in crosswise direction

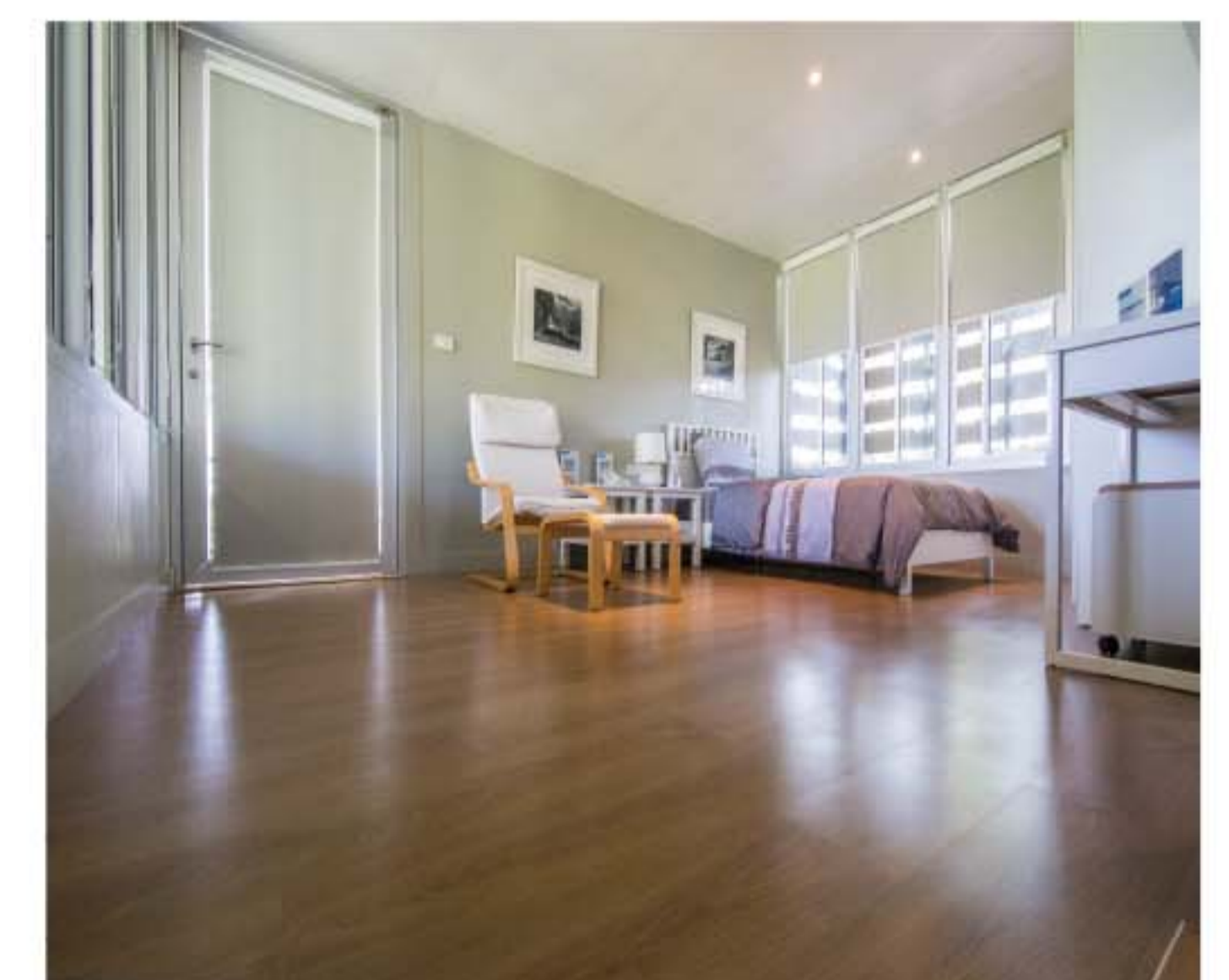

MAXIMUM ALLOWABLE UNIFORMLY DISTRIBUTED LOADS

Board Thickness (mm)	Joist Span (cm x cm) and Loading (kg/m ²)			
	40 x 40	40 x 120	60 x 60	60 x 120
16	590	340	240	-
20	960	550	410	230
24	1400	790	600	340

Remark:

- Loading capability is calculated from minimum bending strength of VIVA Board at 9 N/mm² and engineering safety factor.
- Weight load shown in table is uniformly distributed. Point load, vibration, moving load or impact are excluded.
- Frame width must be sufficient to support all edges.
- Using entire boards for flooring to maximize weight load support.

VIVA Roof & Ceiling

Flat Roof

VIVA Board:	16 - 24 mm
Installation Type:	Firm
Frame:	Galvanized steel C purlin
Frame Spacing:	@ 40-60 cm
Fixing:	On principal and common frame
Finishing:	PVC water proofing membrane

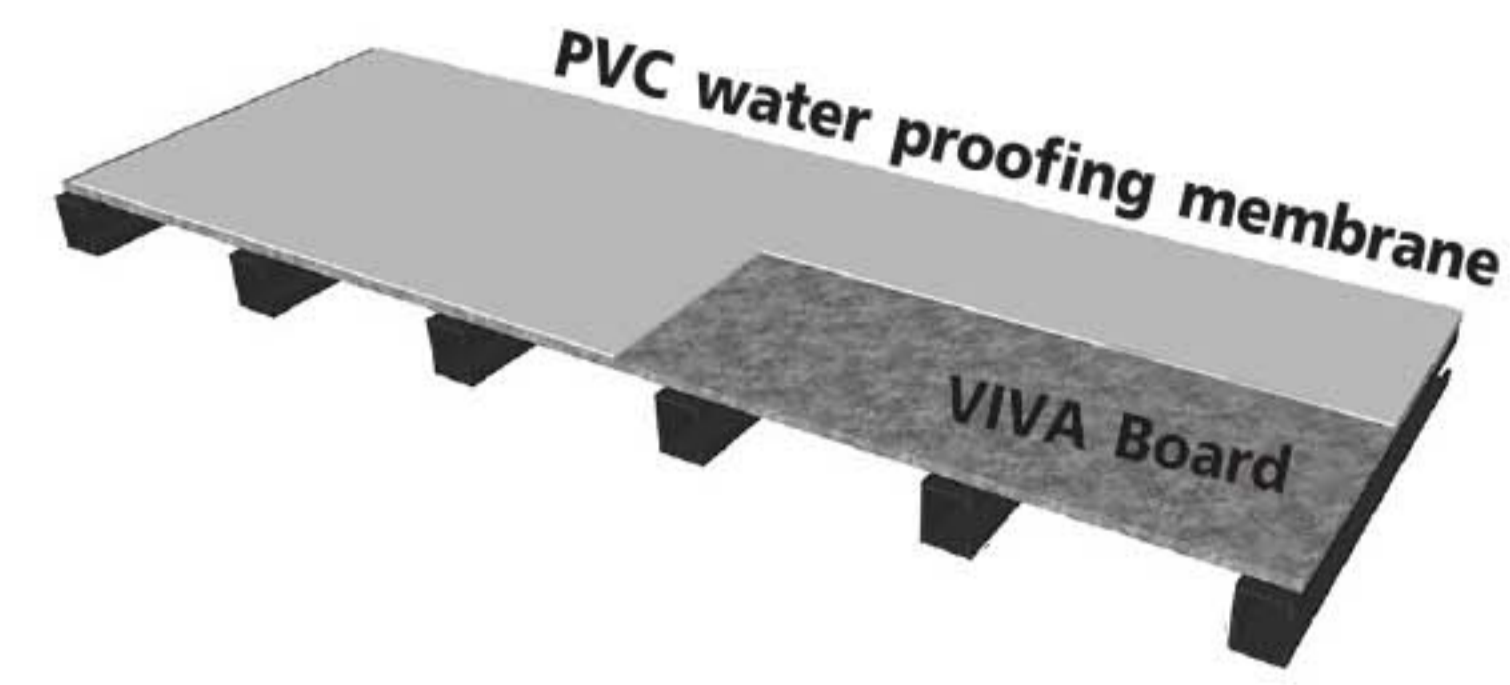

Performance Roof – Heat and Sound Resistance Solution

VIVA Board:	10 - 16 mm
Installation Type:	Firm
Frame:	Galvanized steel C purlin
Frame Spacing:	@ 40-60 cm
Fixing:	On principal and common frame
Finishing:	Metal sheet
Instruction:	Lay heat or sound insulations on VIVA board deck before covering with metal sheet

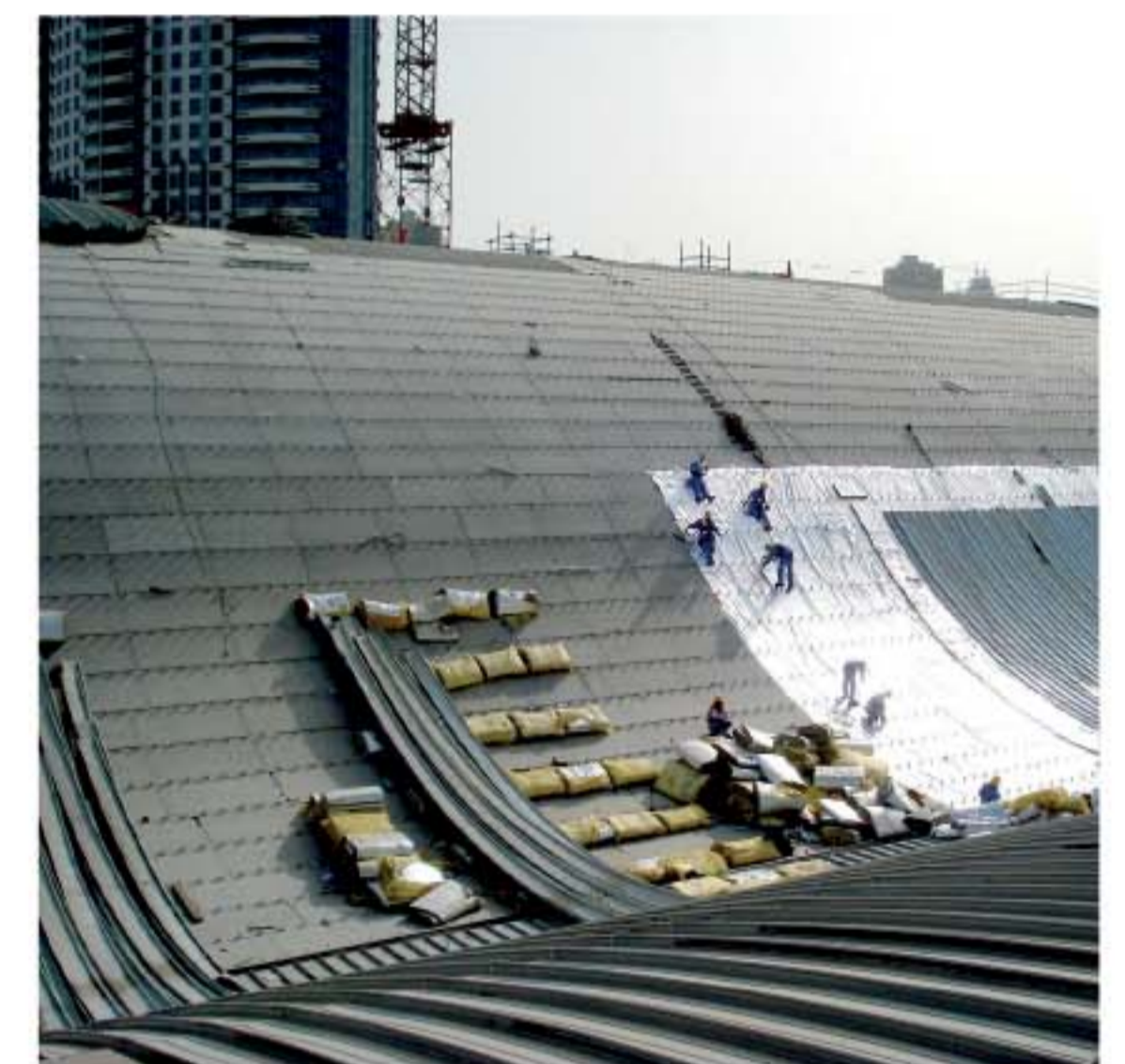
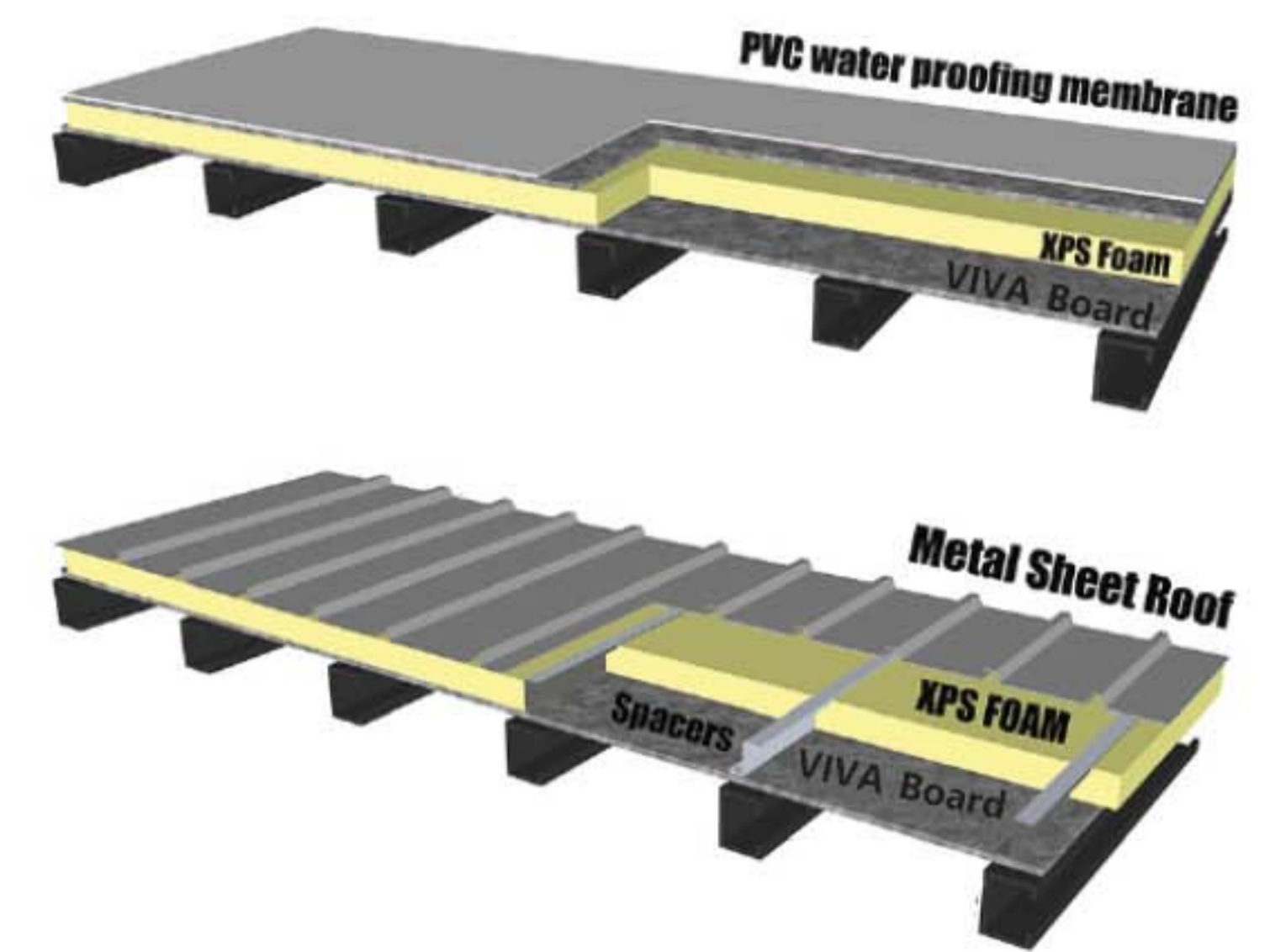

Sub Roof/Roof Decking

VIVA Board:	10 - 16 mm
Installation Type:	Firm
Frame:	Galvanized steel C purlin
Frame Spacing:	@ 60 cm
Fixing:	On principal and common frame
Finishing:	Roof tile, shingle
Instruction:	Lay water proofing membrane on VIVA board deck before attaching covering material

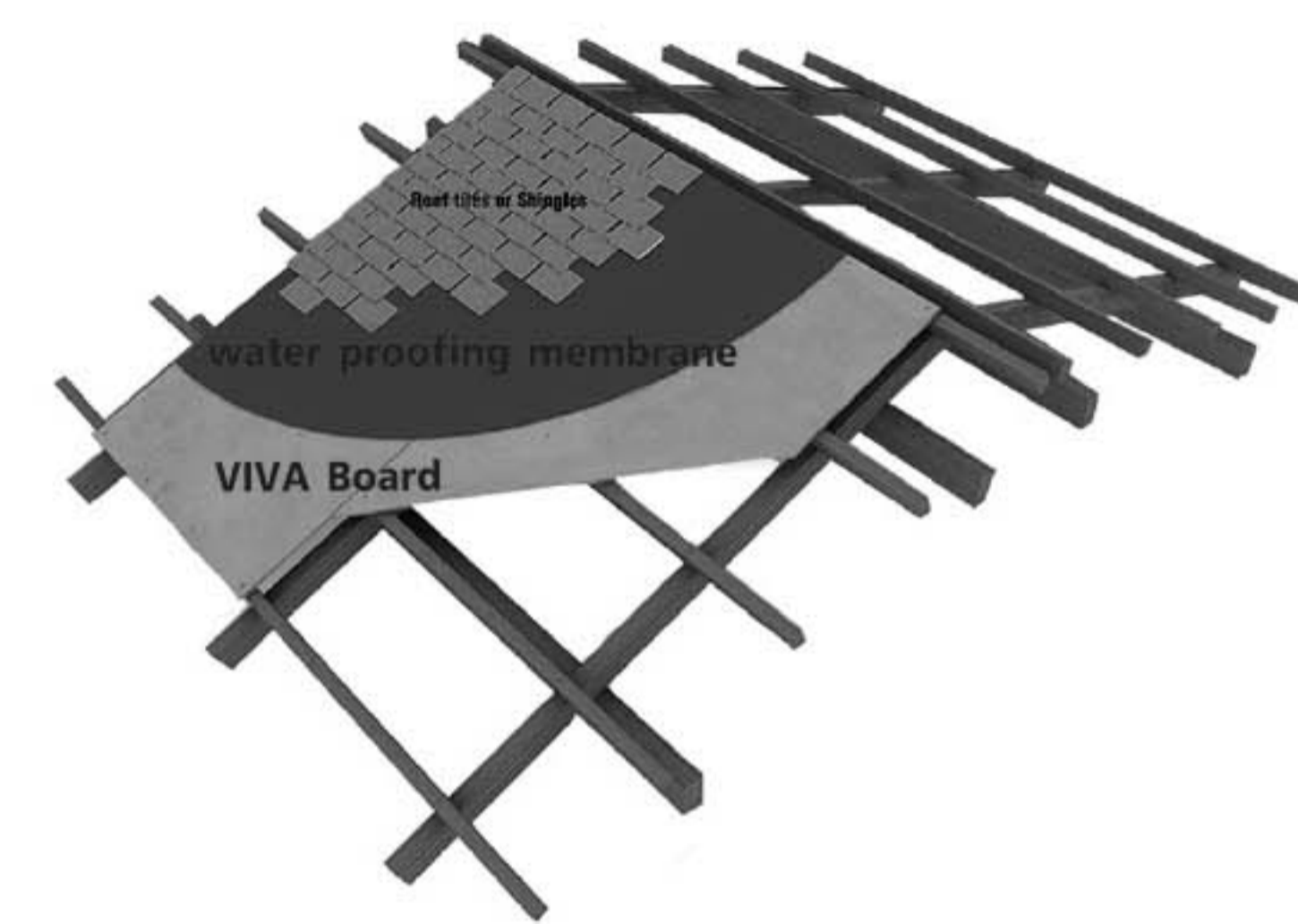

Fixed Ceiling

VIVA Board:	8 mm
Installation Type:	Flex
Frame:	Galvanized steel ceiling section
Frame Spacing:	@ 40 cm
Fixing:	On principal frame
Finishing:	Acrylic paint



T-bar Ceiling

VIVA Board:	8 mm
Installation Type:	Flex
Frame:	T-bar section
Fixing:	On principal frame
Finishing:	Acrylic paint
Instruction:	<ul style="list-style-type: none"> • Cut boards to size 60 x 60 cm or 60 x 120 cm • Apply primer on both sides of boards to prevent warping • Coat front side with acrylic paint

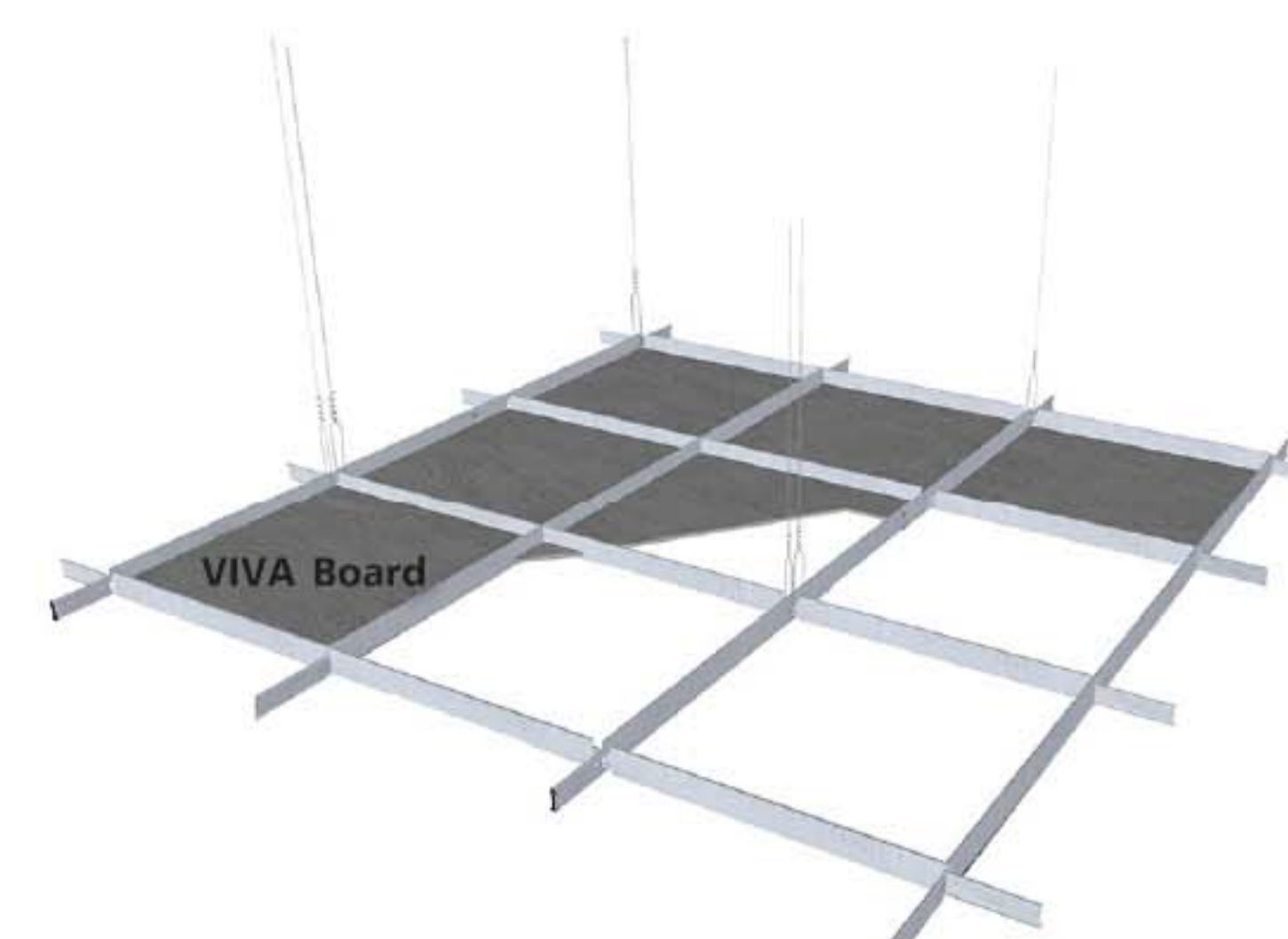

VIVA Installation Instruction

FLEX AND FIRM

VIVA Board is a combination of wood and cement. It inherits many properties of the two main components. It is weather resistant like cement. However, like any boards with wood or wood derived component, it has a degree of moisture movement, meaning that it contracts and expands in relation to changes in ambient moisture and temperature. The direction and degree of movement can be predicted and must be taken into account when installing the boards. Board should be fixed by a method that allows linear movement in most situations. This eliminates formal movement such as warping and bowling and prevents damages. Paint and coating reduces degree of movement. When covering material is applied, boards should be fixed firmly to minimize movement. **Following are the two installation methods: Flex and Firm Installation**

FLEX Installation

- Frame is assembled to allow movement when board is exposed to high degree of changes in temperature and moisture.
- Two pieces of steel frame should be used at joint between boards. If timber frame is used, two pieces of frame at joint between boards is not necessary.

For VIVA Easy Wall, VIVA Deco Wall, VIVA Build and VIVA Clad

- Use only vertical frame. Attach frame to supporting structure by fixing it to L-shape bracket or 'U' Track.
- Apply two pieces of frame at joint between boards. Fix frame together by using screws to allow some movement.
- Recommend strengthen the frame by fixing 'U' galvanized steel frame at every 120 cm.
- Top Hat section can substitute two pieces of 'C' section frame by placing Top Hat inversely wing-up. VIVA Boards shall be fixed on different wings.

For VIVA Deco Floor and VIVA Ceiling

- Set principal joist cross-wise from board direction at 30 cm, 40 cm or 60 cm. Set common joist to support the long edges.
- Apply two pieces of frame at joint between boards. Fix joint together by using screws to allow some movement.

FIRM Installation

- Frame is rigidly assembled to prevent untoward results due to board movement when a covering material such as ceramic tile or wood flooring is applied.

For VIVA Covered Wall, VIVA Combi Wall, VIVA Wet Area, VIVA Floor and VIVA Roof

- Set frame at 30 cm x 30 cm, 40 cm x 40 cm, or 60 cm x 60 cm depending on required rigidity and load capability.
- Firmly assemble the frame together by welding or screwing
- If a single frame's width is insufficient, two frames at the joint between boards are recommended. Frame must be welded together to ensure no frame's movement.
- Provide control joint (movement joint) at every 4.8 - 6 meters and around the room's perimeter by using flex installation method to allow movement.

Board Fixing

Fix boards along principal studs/joists only

Gap between boards

Interior 3 - 5 mm

Exterior 5 - 10 mm

Caulking Material

Polyurethane Sealant

Board Fixing

Fix boards on both vertical and horizontal direction along principal and common studs/joists.

Gap between boards

2 - 3 mm

Caulking Material

Epoxy

Note: Leave 10 mm gap for control joint and fill gap with Polyurethane Sealant.

Fixing Distance

Fixing distance from edge	Fixing distance from corner	VIVA Board	Distance between edge fixing 'A'	Distance between center fixing 'B'
Flex Installation: 30 mm	75 mm	8 - 16 mm	150 - 200 mm	200 - 300 mm
Firm Installation: 20 mm		20 - 24 mm	200 - 300 mm	300 - 400 mm

Fixing and Joint Details: FLEX Installation

Wall Application

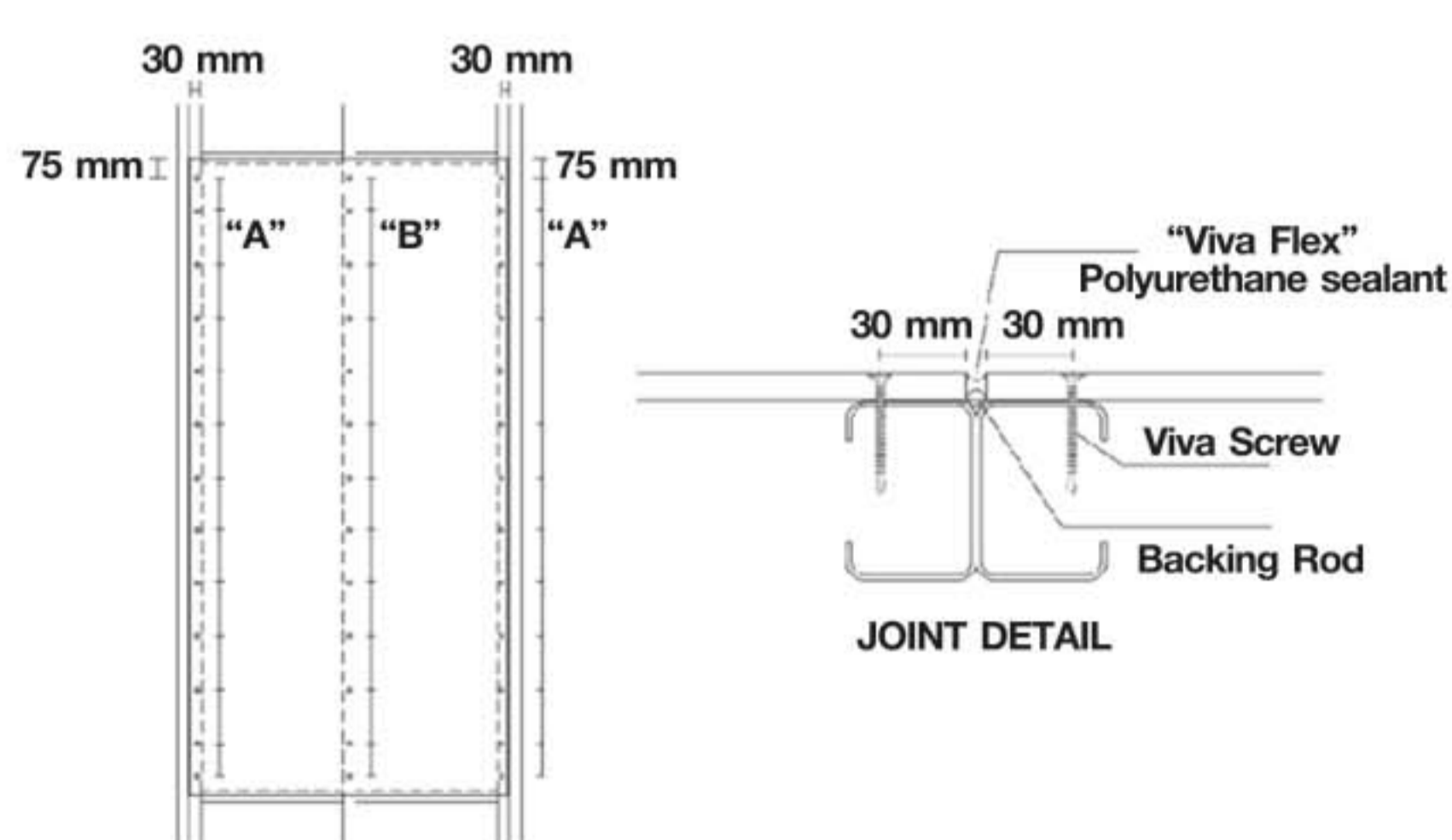

Floor Application

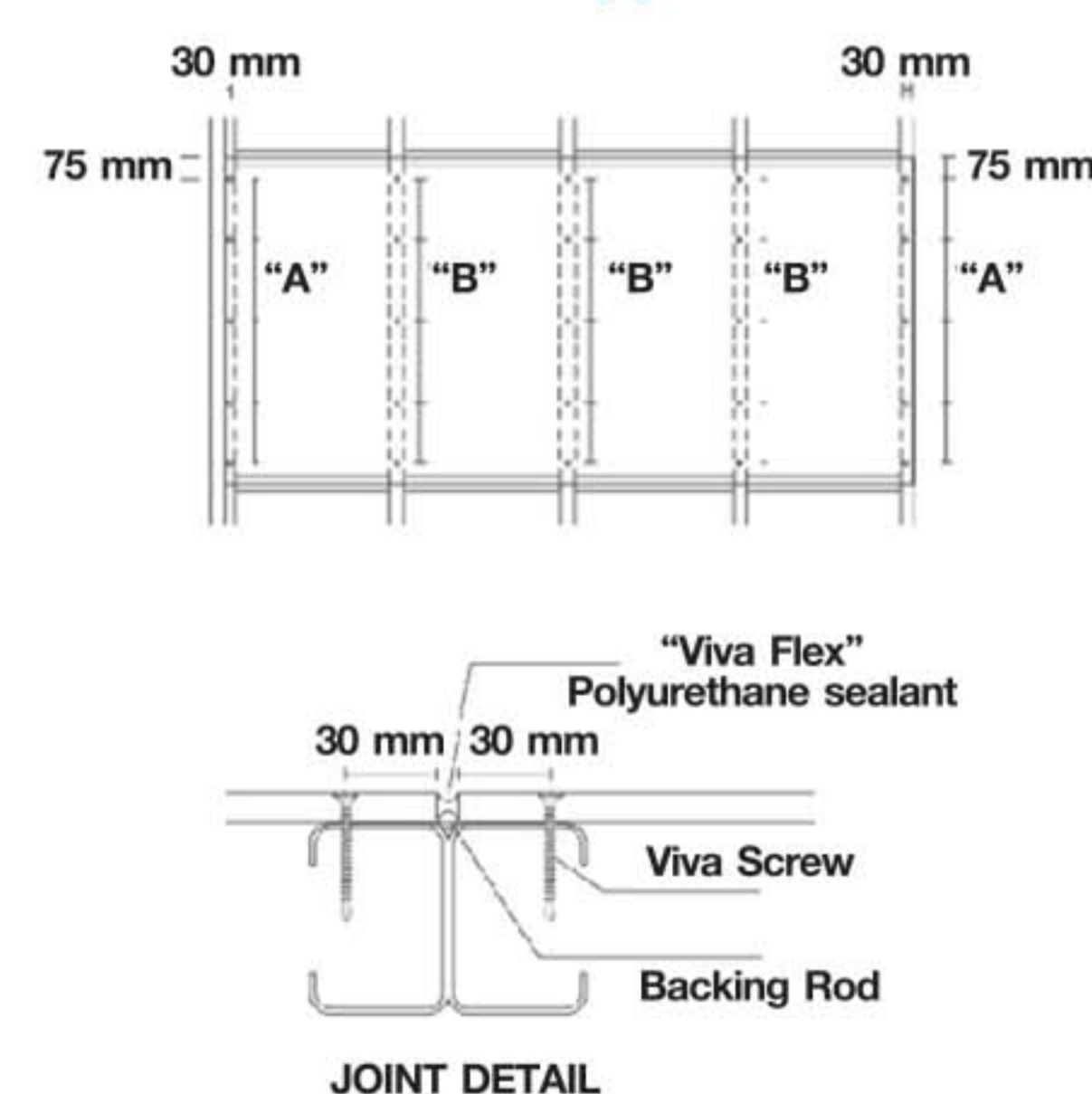

Fixing and Joint Details: FIRM Installation

Wall Application

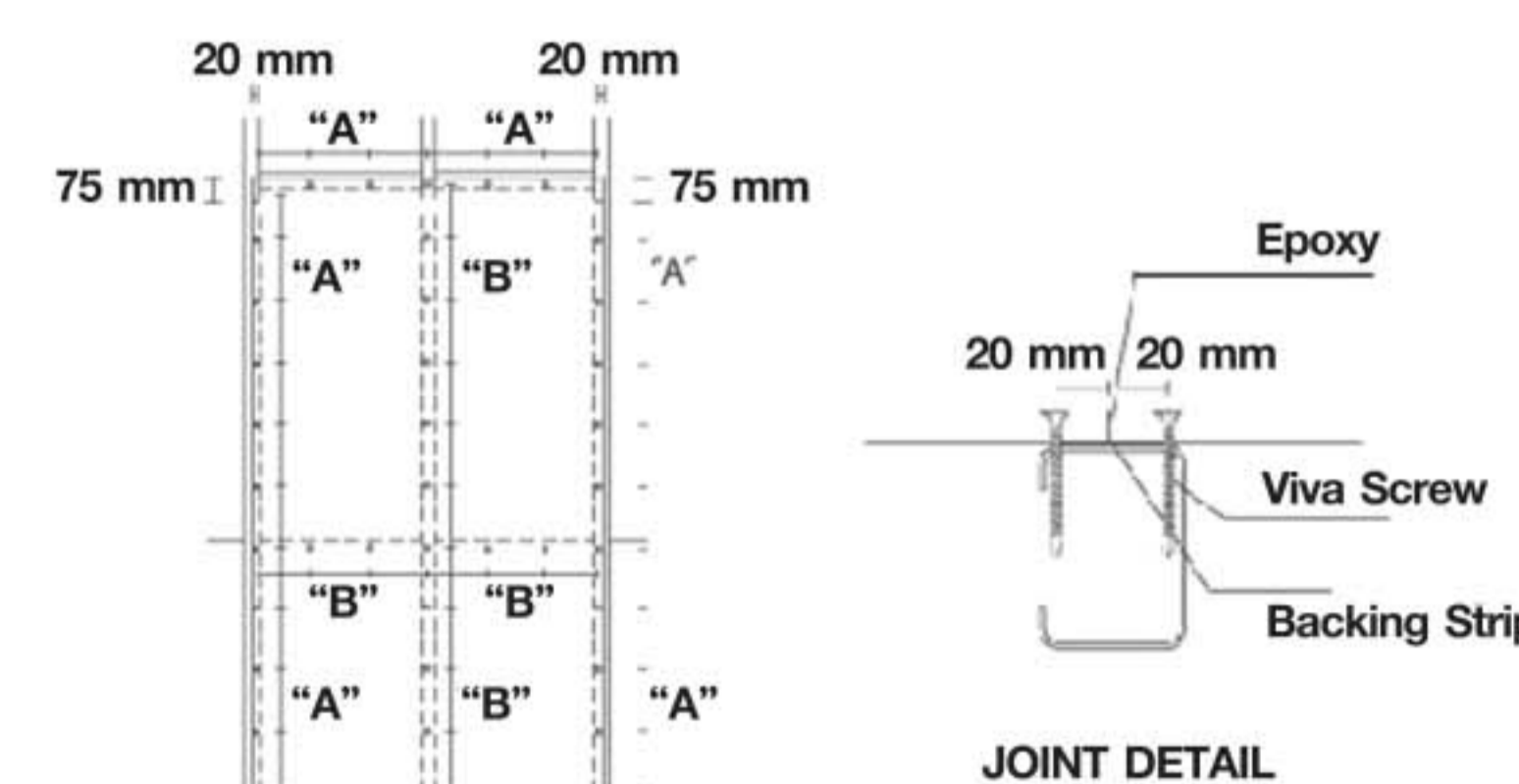

Floor Application

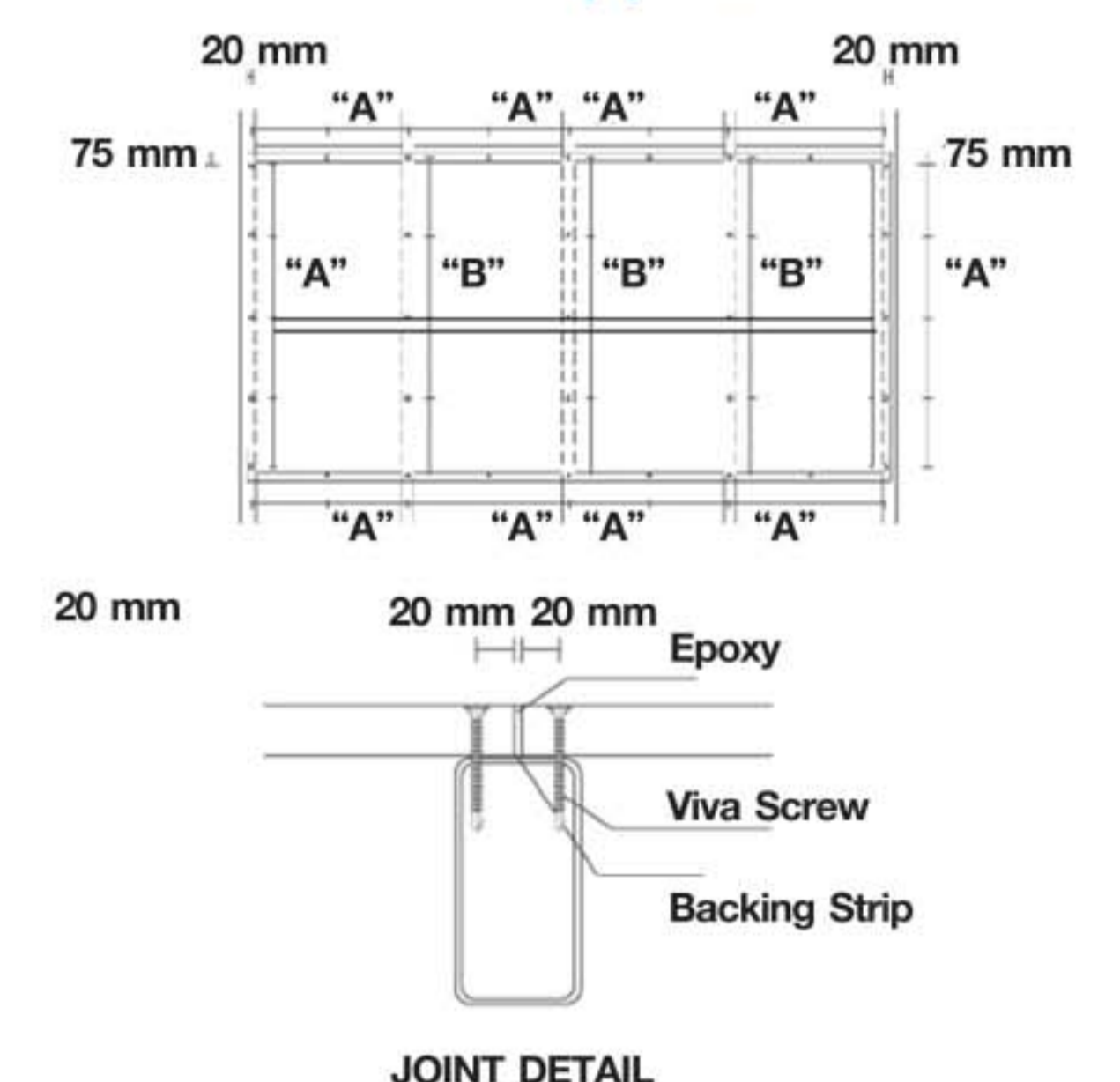

Staggered Pattern

Control Joint Control Joint Control Joint
4.8-6.0 m / 4.8-6.0 m / 4.8-6.0 m

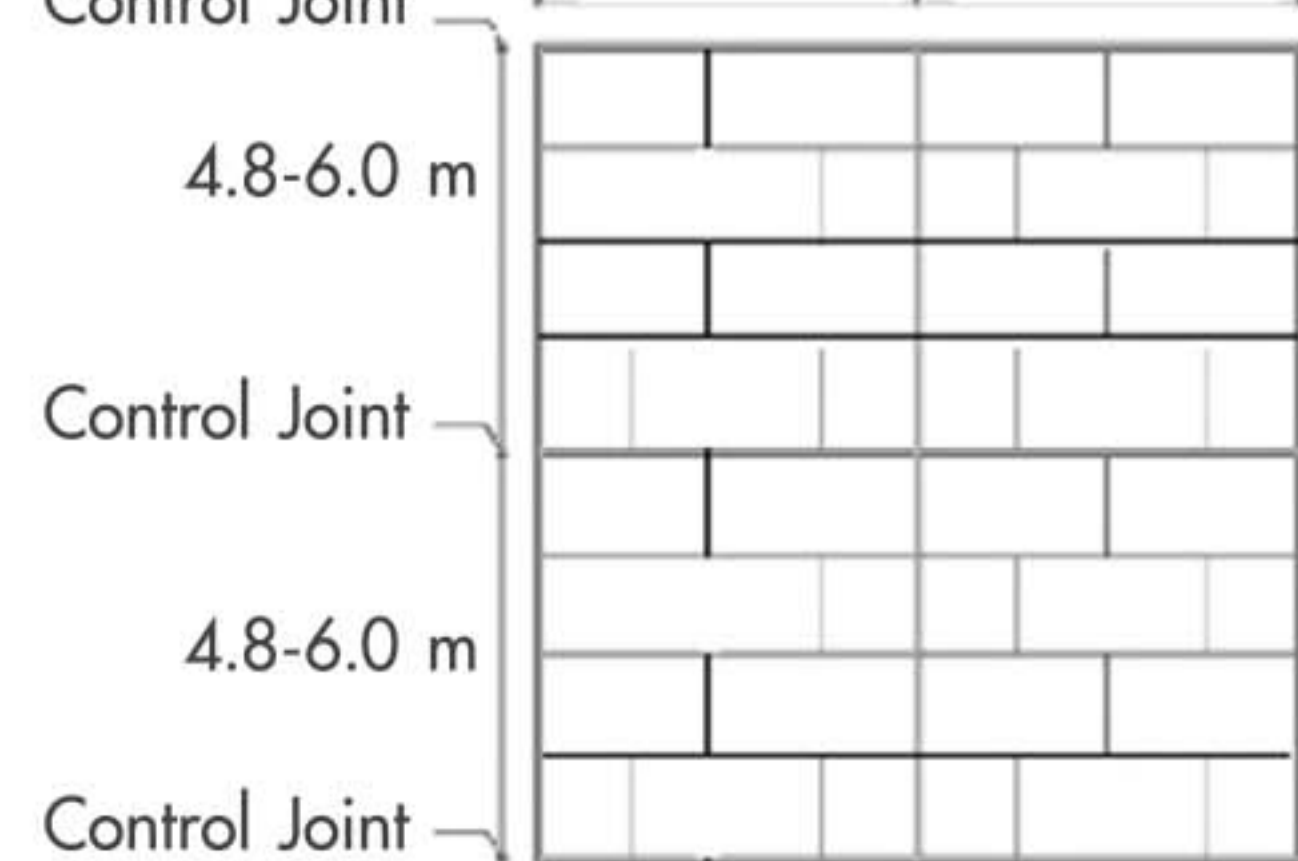

Control Joint

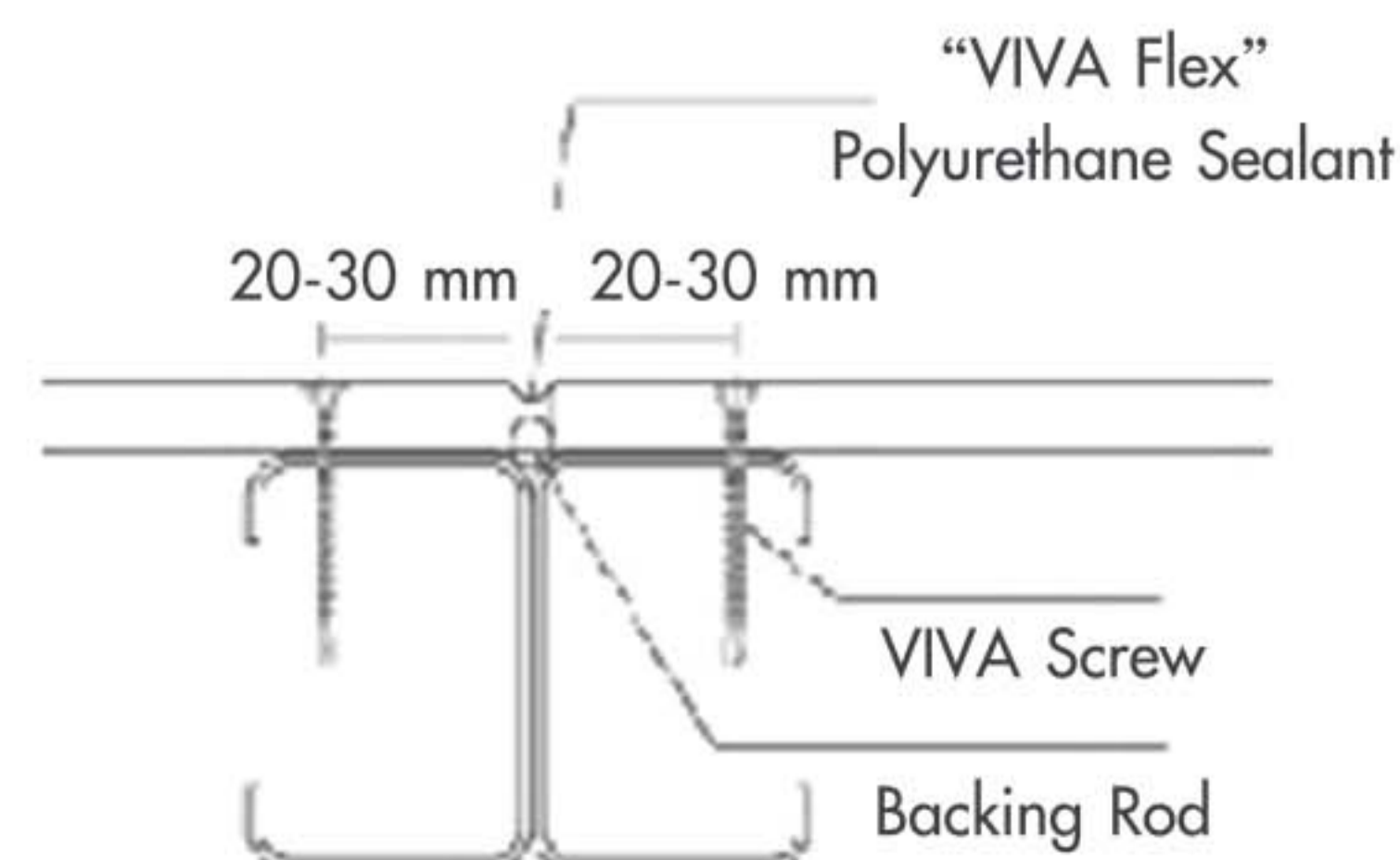

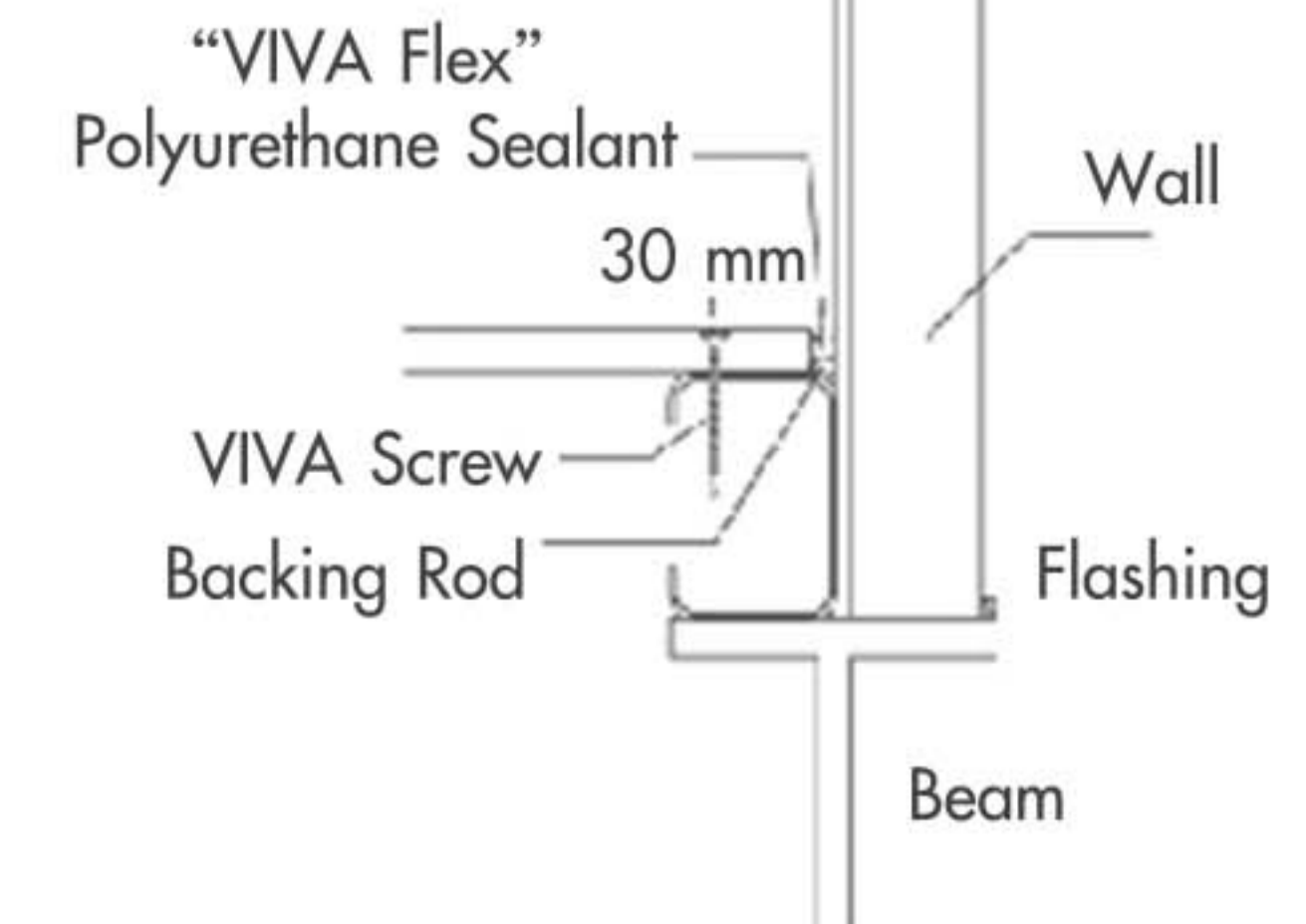

Control Joint Detail



Room joint Detail

FRAME SELECTION

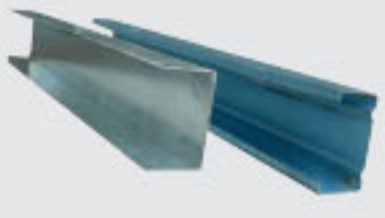
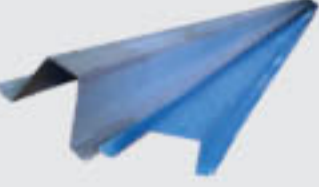
RECOMMENDED FRAME TYPE

Frame Type		Size	Thickness	Flexibility	Recommended Applications
Timber Frame		1½ x 3"		High	VIVA Deco Wall, VIVA Easy Wall
'C' and 'U' Galvanized Steel		C75 U76	0.5 mm	High	VIVA Easy Wall, VIVA Build (residential building), VIVA Combi Wall
Top Hat Section		65 x 30 mm	0.7 - 1.0 mm	High	VIVA Clad, VIVA Deco Wall (exterior)
'C' Light Gauge Steel		75 x 45 x 15 mm	1.6 mm	Low	VIVA Build (public building), VIVA Covered Wall, VIVA Wet Area
		100-150 x 50 x 20 mm	2.3 - 3.2 mm	Very Low	VIVA Deco Floor
Light Gauge Box Section		100-150 x 50 mm	2.3 - 3.2 mm	No Flexibility	VIVA Floor with covering material

Working with VIVA BOARD

- Cutting:** VIVA Board can be cut with portable circular saw with tungsten carbide tipped blade or jigsaw. Crosscut hand saw can be used for thickness up to 12 mm.
- Milling:** VIVA Board can be milled for half-lap, tongue and groove, tapered and etc. The milling tip should be made of tungsten carbide. Please note that minimal thickness of board should be considered when milling.
- Grinding:** Manual grinding or electric hand-held grinding tools with abrasive paper of 40 - 80 granularity can be used at joint areas of boards when boards' evenness is needed or the board surface should be coarsened.
- Screwing:** VIVA Screw is recommended because it allows drilling and countersinking in one step. When using self-tapping screw, pre-drilling with slightly oversized hole is required.
- Screw Head Covering:** Touch-up the screw heads with acrylic filler, epoxy putty or VIVA epoxy. To match screw head color with VIVA board, use a mixture of Portland cement, adhesive, saw dust and pigment.
- Nailing:** VIVA Board up to 10 mm thickness can be manually nailed onto timber frame without pre-drilling.
- Wide Opening:** In cutting a wide opening such as door or window, studs should be placed around the perimeter of the opening to sufficiently reinforce the opening.
- Flashing:** For exterior applications, flashing should be installed for the areas such as window and door frame, adjoining wall, opening, and top corner to prevent water leakage.



SURFACE TREATMENT

Application	Painting	Coating
Interior	Acrylic paint Epoxy paint	Lacquer Gloss epoxy Gloss/Matte polyurethane Viva Clear Guard
Exterior	Exterior acrylic paint Polyurethane paint Wood stain	Gloss/Matte polyurethane Viva Clear Guard

- Remark:**
- Alkaline resisting primer should always be applied as base before painting due to alkalinity of VIVA Board's surface.
 - The board surface should be clean and dry before paint or coating.
 - Oil-based paint is not recommended to use with VIVA Board.
 - Applying paint or primer on the back side of the board ensure that the board is better conditioned for use where there are changes in moisture content and temperature of the board or where conditions on two sides of the boards differ substantially e.g. T-Bar ceiling.
 - For applications used in high humidity area, moisture resistant coating should be applied to both surfaces before applying covering materials.
 - Each paint and coating type has its special properties; please consult the paint manufacturer for more details.
 - Exterior floor in natural finish or painting is not recommended.

Storage

- VIVA Board must be stored under a roofed area, in a dry environment and well protected from weather. Floor area should be leveled and solid.
- VIVA Board should be stored in its original packing supplied.
- If taken out from the pallets, board can be stacked with the maximum height of 75 cm. The stack shall be laid on 5 bearing plates with maximum of 60 cm space among plates. The stack shall be covered with waterproof protective plastic sheet.
- Maximum of 4 pallets or stacks shall be laid on top of each other.
- VIVA Board must never be stored on edge or upright. Outdoor storage is not recommended.

Transportation

- VIVA Board should be laid flat and be adequately protected during transportation by waterproof covering.
- Lifting the board from its stack should be done one piece at a time by sliding to the side. Never lift VIVA Board from its both ends because it may cause the boards to bend resulting in board breakage. VIVA Board must be carried in a vertical position.

Conditioning

- VIVA Board should be allowed 24 - 48 hours to adapt to the ambient humidity level prior fixing for its most capability working conditions. If the board gets wet, it should be allowed to dry individually prior to installation.





VIVA BOARD Technical Data

Specific Properties	Unit	Thai Industrial Standard (TIS 878-2537)	VIVA BOARD (Average Test result)
Density	kg/m ³	1100 – 1300	1300
Moisture Content	%	9 – 15	9 – 15
Bending Strength	N/mm ²	≥ 9	12
Modulus of Elasticity	N/mm ²	≥ 3000	5000
Tensile Strength Perpendicular to Plane	N/mm ²	≥ 0.5	0.7
Thermal Conductivity (K Value)	W/m °c	≤ 0.25	0.1
Thickness Swelling (after 24 hours immersed in water)	%	≤ 2	1

Other Properties	VIVA BOARD (Average Test Result)		
Surface Alkalinity	pH		12
Length Change (after 24 hours immersed in water)	%		0.12
Water Absorption (after 24 hours immersed in water)	%		12

Fire Resistance Properties

 VIVA Board contains high percentage of cement content permitting it to be highly fire-resistant. VIVA Board passed BS 476 Part 6 and 7 and is classified as virtually non-combustible or class 'O' material and it is also classified as class 'B' according to BS EN 13501-1.

 VIVA Board partition system also passed the 1-hour, 2-hour and 4-hour fire rating test according to BS 476 Part 22, proving its fire prevention capability.

Dimensional Tolerance (mm)

- Diagonal	± 4.0
- Length/ Width	± 2.0
- Thickness 8 – 12 mm	± 1.0
- Thickness 16 – 20 mm	± 1.5
- Thickness 24 mm	± 2.0

Sound Insulating Properties

Thickness (mm)	STC Rating
8	28
10	29
12	30
16	31
20	32

 Due to its high density, VIVA Board contributes significant sound insulating performance than any other types of building boards.

Remark: Please consult the manufacturer for more details of fire resistance and sound insulating solutions.

Features and Benefits



VIVA BOARD

CEMENT BONDED PARTICLE BOARD

VIVA INDUSTRIES CO., LTD.

1000/17 Liberty Plaza Building, Floor No. 14, Soi Sukhumvit 55 (Thonglor), Sukhumvit Road
Klongtonnua, Vadhana, Bangkok 10110, Thailand Phone: (66-2) 3816453 Fax: (66-2) 3812400
Website: www.viva.co.th E-mail: vivaboard@viva.co.th